

# Permitted development for householders

## Technical guidance

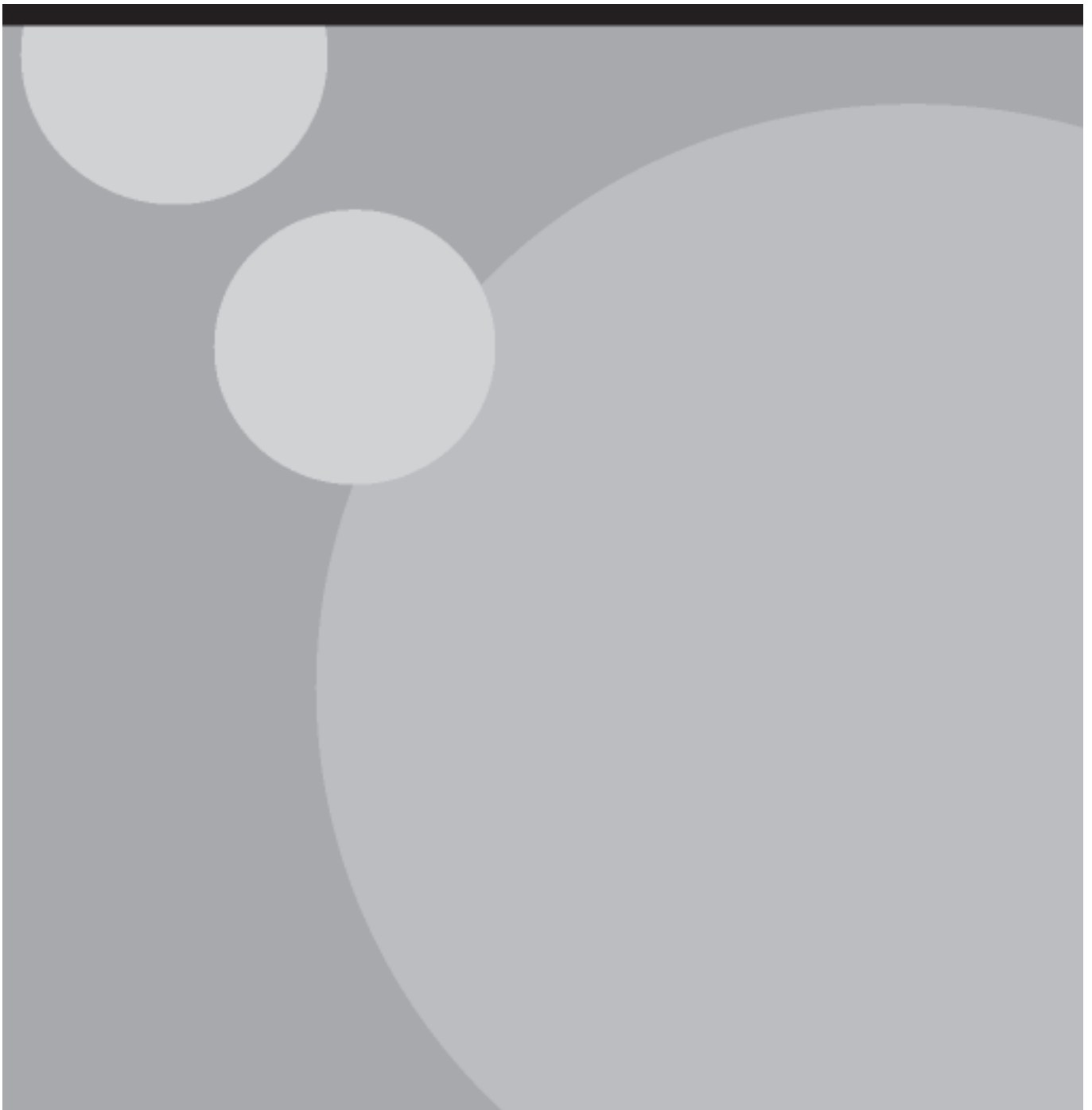



# Permitted development for householders

## **Technical guidance**

This technical guidance was commissioned and written under the last Government

Department for Communities and Local Government  
Eland House  
Bressenden Place  
London  
SW1E 5DU  
Telephone: 0303 444 0000  
Website: [www.communities.gov.uk](http://www.communities.gov.uk)

© Crown Copyright, 2010

*Copyright in the typographical arrangement rests with the Crown.*

*This publication, excluding logos, may be reproduced free of charge in any format or medium for research, private study or for internal circulation within an organisation. This is subject to it being reproduced accurately and not used in a misleading context. The material must be acknowledged as Crown copyright and the title of the publication specified.*

Any other use of the contents of this publication would require a copyright licence. Please apply for a Click-Use Licence for core material at [www.opsi.gov.uk/click-use/system/online/pLogin.asp](http://www.opsi.gov.uk/click-use/system/online/pLogin.asp), or by writing to the Office of Public Sector Information, Information Policy Team, Kew, Richmond, Surrey TW9 4DU

e-mail: [licensing@opsi.gov.uk](mailto:licensing@opsi.gov.uk)

If you require this publication in an alternative format please email [alternativeformats@communities.gsi.gov.uk](mailto:alternativeformats@communities.gsi.gov.uk)

Communities and Local Government Publications  
Tel: 0300 123 1124  
Fax: 0300 123 1125  
Email: [product@communities.gsi.gov.uk](mailto:product@communities.gsi.gov.uk)  
Online via the Communities and Local Government website: [www.communities.gov.uk](http://www.communities.gov.uk)

August 2010

ISBN: 978-1-4098-2493-0

# Contents

<b>Introduction</b>	<b>5</b>
<b>Class A</b>	<b>9</b>
<b>Class B</b>	<b>32</b>
<b>Class C</b>	<b>37</b>
<b>Class D</b>	<b>39</b>
<b>Class E</b>	<b>40</b>
<b>Other classes under Part 1</b>	<b>46</b>
<b>Interpretation of Part 1</b>	<b>49</b>

# Introduction

This technical guidance from Communities and Local Government (CLG) was commissioned and written under the last Government. It is designed to help understand the changes made to the Town and Country Planning (General Permitted Development) Order 1995 by the Town and Country Planning (General Permitted Development) (Amendment) (No.2) (England) Order 2008.<sup>1</sup> This sets out the rules concerning what extensions, improvements and alterations a householder may make to their house and the area around it without the need for an application for planning permission. Such works are known as 'permitted development'.

The guidance replaces earlier guidance (*Changes to Householder Permitted Development 1 October 2008 - Informal Views from Communities and Local Government*) that was published on the Planning Portal in December 2008. This earlier guidance was produced primarily for planning professionals. The new guidance is designed to be used by anyone who wants to understand more about the detailed rules on permitted development and the terms used in those rules. However, anyone who has no previous knowledge of permitted development issues will find it useful to look at the basic information on the Planning Portal first at:

[www.planningportal.gov.uk/england/public/tools/house](http://www.planningportal.gov.uk/england/public/tools/house).

The guidance set out below gives an explanation of the rules on permitted development for householders, what these mean and how they should be applied in particular sets of circumstances. Diagrams have been included for illustrative purposes only and these are not drawn to scale. Given the very substantial variations in the design of individual houses, this guide cannot cover all possible situations that may arise. Where there is any doubt as to whether a development would be permitted development, advice should be sought from the local planning authority. To be certain that a proposed development is lawful and does not require an application for planning permission, it is possible to apply for a 'Lawful Development Certificate' from the local authority. Further information on this can be found on the Planning Portal at:

[www.planningportal.gov.uk/england/public/buildingwork/responsibilities/workresppp/workresppldc](http://www.planningportal.gov.uk/england/public/buildingwork/responsibilities/workresppp/workresppldc)

---

<sup>1</sup> This can be viewed at: [www.opsi.gov.uk/si/si2008/uksi\\_20082362\\_en\\_1](http://www.opsi.gov.uk/si/si2008/uksi_20082362_en_1)

## General issues

The 2008 rules on household permitted development amended rules from 1995.<sup>2</sup> However, some of the terms used in the 2008 rules remain as defined in 1995. These include:

*'dwellinghouse'* - does not include buildings containing one or more flats or a single flat contained within a building. *Note, however, that for the purposes of this guidance, the word 'house' is used rather than 'dwellinghouse' unless the legislation is quoted directly.*

*'Building'* - includes any part of a building and includes any structure or erection, but does not include mechanical plant or machinery or gates, fences, walls, or other means of enclosure.

*'Original'* - means a building as it existed on 1 July 1948 where it was built before that date, and as it was built when built after that date.

*'Existing'* - means a building as it existed immediately before any permitted development (eg a house extension) is undertaken. *The existing house will include previous development to the house, whether undertaken as permitted development or as development resulting from a planning permission from the local authority.*

*'Height'* - references to height (for example, the heights of the eaves on a house extension) is the height measured from ground level.<sup>3</sup> Ground level is the surface of the ground immediately adjacent to the building in question. Where ground level is not uniform (e.g. if the ground is sloping), then the ground level is the highest part of the surface of the ground next to the building.

*'Article 1(5) land'* - this is land within a National Park, the Broads, an area of outstanding natural beauty, an area designated as a conservation area, and land within World Heritage Sites.

---

<sup>2</sup> The Town and Country Planning (General Permitted Development) Order 1995. This can be viewed at: [www.opsi.gov.uk/si/si1995/Uksi\\_19950418\\_en\\_1.htm](http://www.opsi.gov.uk/si/si1995/Uksi_19950418_en_1.htm)

<sup>3</sup> This will be the level of the natural ground and would not include any addition laid on top of the natural ground such as a patio.

## The structure of the rules on permitted development

The rules on permitted development are sub-divided into a series of 'Parts'. Part 1 specifically deals with development within the curtilage of a house (this is usually the area of land within which the house sits, but for some houses, may be a smaller area). Part 1 is then sub-divided into Classes covering various types of development:

**Class A** covers the enlargement, improvement or alterations to a house such as rear or side extensions as well as general alterations such as new windows and doors.

**Class B** covers additions or alterations to roofs which enlarge the house such as loft conversions involving dormer windows.

**Class C** covers other alterations to roofs such as re-roofing or the installation of roof lights.

**Class D** covers the erection of a porch outside an external door.

**Class E** covers the provision of buildings and other development on land surrounding the house (the 'curtilage').

**Class F** covers the provision of hard surfaces on land surrounding the house such as driveways.

**Class G** covers the installation, alteration, or replacement of a chimney, flue or soil and vent pipe.

**Class H** covers the installation, alteration, or replacement of microwave antenna such as satellite dishes.

There are also other Parts of the rules that may be relevant to householders. For example Part 2 covers matters such as erection or construction of gates, fences and walls. Part 40 covers the installation of domestic microgeneration equipment (such as solar panels).

When considering whether a development proposal is permitted development, all of the relevant Parts of the rules and all the Classes within those Parts need to be taken into account. So whilst Part 1 Class A prevents the installation, alteration or replacement of a chimney, flue or soil and vent pipe from being permitted development, Class G includes such development as permitted development subject to the rules set out under that Class.

Similarly, changes to the roof of a house are not permitted development under Class A, but may be permitted development under Class B or C. For example, where a proposed two storey extension at the rear of a house has a roof that joins onto the main roof of the original house, the works will need to meet the requirements of both Class A (which covers the enlargement of the house) and Class C (which covers any alterations to the roof) in order to be permitted development. If the works also include the creation of a dormer window to enlarge the roof space, either in the

extension or the original roof space, then they would also need to meet the requirements of Class B.

In order to be permitted development, a proposal must meet all the limitations and conditions under the Classes relevant to the proposal.

It is therefore essential that any proposed household development is considered in the context of the permitted development rules as a whole in order to determine whether it benefits from permitted development rights and therefore does not require an application for planning permission.

## Further restrictions on permitted development

A local planning authority may have removed some permitted development rights by issuing what is known as an Article 4 Direction or may have removed those rights on the original, or any subsequent, planning permission for the house. This will mean a planning application will be needed for development which normally does not need one. Before undertaking any development, checks should be undertaken with the local planning authority to determine whether any restrictions on permitted development have been made.

The remainder of this guidance provides further explanation about the detailed rules covering what improvements can be made to a house and its surroundings as permitted development. In particular, it provides more details on the limits (e.g. on size) and the conditions that will need to be complied with if development is to take place without the need for an application for planning permission. The guidance covers in detail Classes A-E of the rules which cover common development projects such as extensions, loft conversions, alterations to a roof, porches, and buildings on land surrounding the house. The rules for Classes F-H are included in this document; detailed guidance on them is not included, although cross-references are included to other guidance published by CLG.



# Class A

This provides permitted development rights for the enlargement, improvement or other alteration of a house.

Under Class A the following limits and conditions apply:

**A.1 Development is not permitted by Class A if:**

- (a) as a result of the works, the total area of ground covered by buildings within the curtilage of the dwellinghouse (other than the original dwellinghouse) would exceed 50% of the total area of the curtilage (excluding the ground area of the original dwellinghouse)**

Extensions (including previous extensions) and other buildings must not exceed 50% of the 'curtilage'. What is defined as the curtilage for a particular house will vary according to a number of factors, but in most cases it will comprise the area of land around the original house (i.e. what is understood to be the garden/grounds of the house). But the curtilage may be a smaller area in some cases, especially in the case of properties with large grounds set in the countryside.

The 50% limit covers all buildings so will include existing and proposed outbuildings as well as any existing or proposed new extensions to a house. It will exclude the area covered by the house itself but will include any separate detached buildings built prior to 1948 (e.g. a detached garage).

In the diagram below, the maximum area that can be built on as permitted development, whether as an extension to the house, or outbuildings erected under Class E would be 50% of the white area.

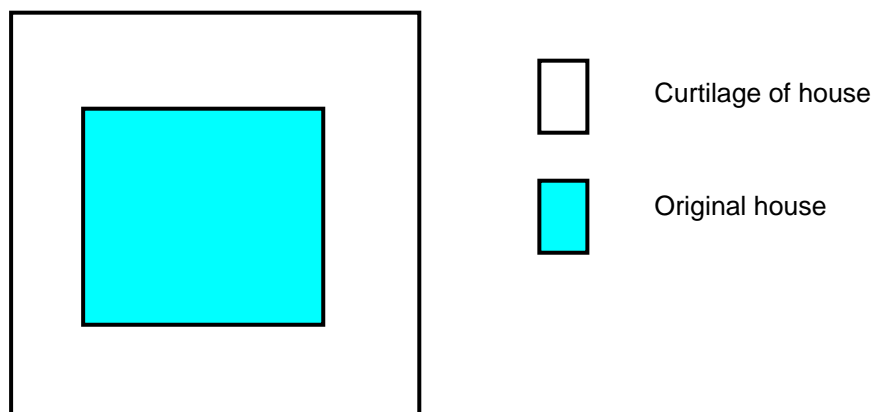

**(b) *the height of the part of the dwellinghouse enlarged, improved or altered would exceed the height of the highest part of the roof of the existing dwellinghouse***

Any enlargement, improvement, or alteration to a house must not exceed the height of the highest part of the roof of the existing house. If it does, an application for planning permission will be required.

The highest part of the roof of the existing dwelling house will be the height of the ridge line of the main roof (even though there may be other ridge lines at a lower level) or the height of the highest roof where roofs on a building are flat.

Chimneys, firewalls, parapet walls and other protrusions above the main roof ridge line should not be taken into account when considering the height of the highest part of the roof of the existing house.

However, when calculating the height of the part of the house enlarged, this measurement should be at the highest part of the enlargement and should include any protrusions above the roof such as parapet walls etc.

**(c) *the height of the eaves of the part of the dwellinghouse enlarged, improved or altered would exceed the height of the eaves of the existing dwellinghouse***

For the purpose of measuring height, the eaves of a house are the point where the lowest point of a roof slope, or a flat roof, meets the outside wall.

The height of the eaves will be measured from the natural ground level at the base of the external wall of the extension to the point where the external wall would meet (if projected upwards) the upper surface of the roof slope. Parapet walls and overhanging parts of eaves should **not** be included in any calculation of eaves height.

The following example shows the side view of an extension with a pitched roof:

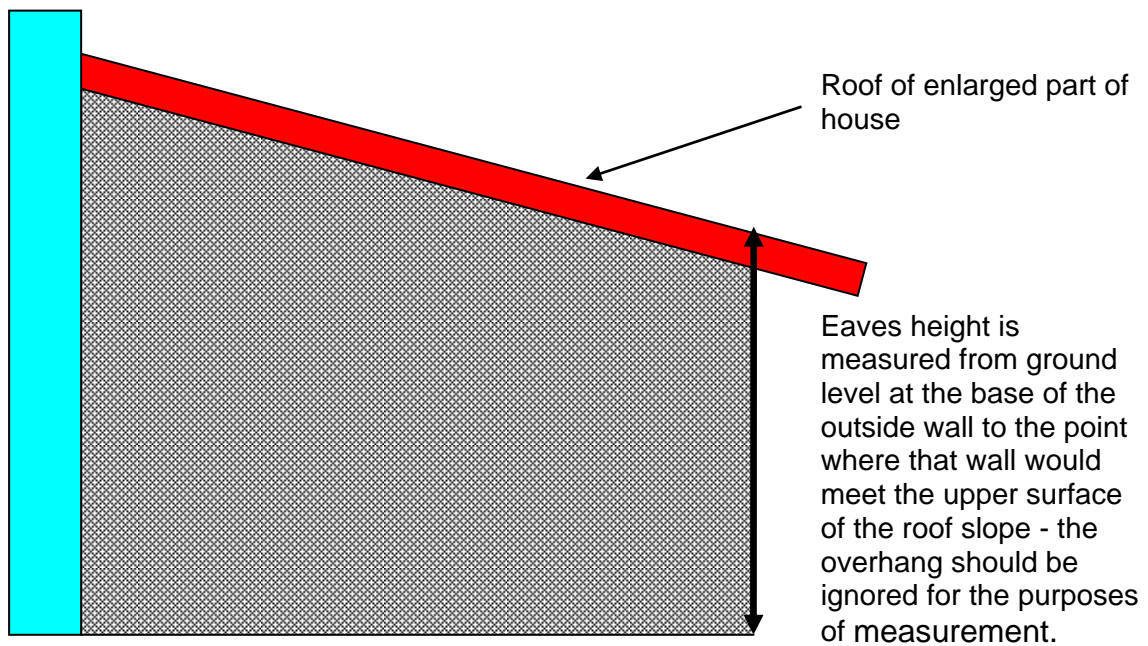

Where there is a flat roof, a similar approach should be taken for measuring eaves:

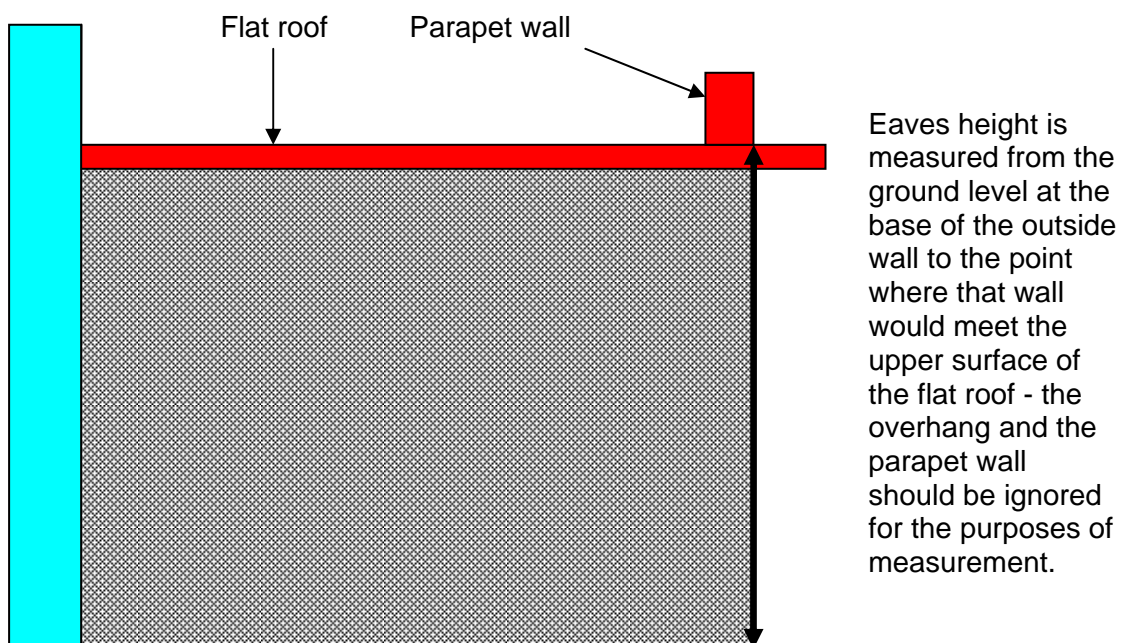

Where the existing house has eaves of different heights, then the restriction on the height of the eaves for the part of the house enlarged, improved or altered is measured against the highest level of eaves on the existing house. However, where a house is built on sloping ground, the height of the eaves on the existing house should be measured in terms of the elevation from which any extension of a house is to be made.

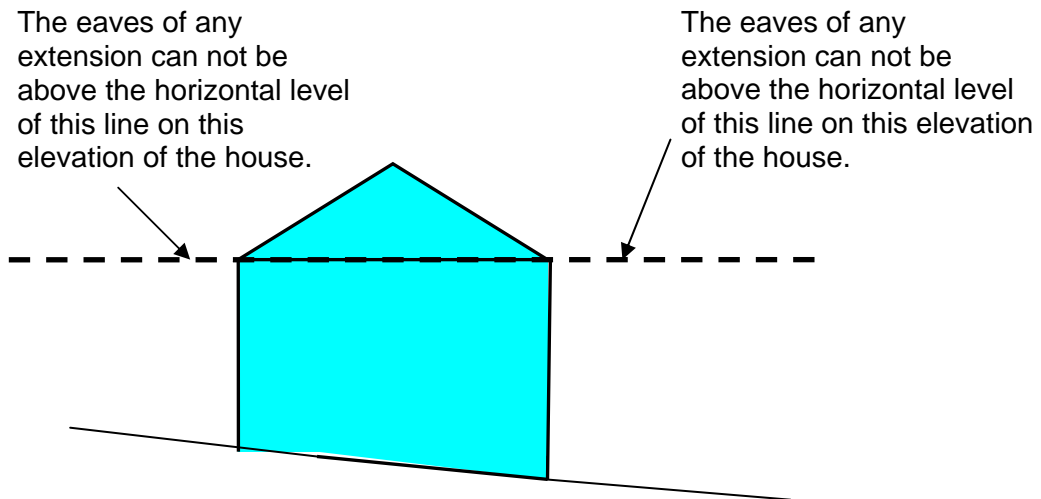

**(d) the enlarged part of the dwellinghouse would extend beyond a wall which:**

**(i) fronts a highway and**

**(ii) forms either the principal elevation or a side elevation of the original dwellinghouse**

This restriction means that any development that is in front of a principal or side wall that fronts a highway will require an application for planning permission.

In most cases, the principal elevation will be that part of the house which fronts (directly or at an angle) the main highway serving the house (the main highway will be the one that sets the postcode for the house concerned). It will usually contain the main architectural features such as main bay windows or a porch serving the main entrance to the house. Usually, but not exclusively, the principal elevation will be what is understood to be the front of the house.

There will only be one principal elevation on a house. Where there are two elevations which may have the character of a principal elevation (for example, on a corner plot), a view will need to be taken as to which of these forms the principal elevation. Note, however, that in such cases the second elevation will also be subject to the restrictions under Class A if it is a side elevation and fronts a highway.

In this context, 'extend beyond a wall' comprises not only the area immediately in front of the wall, but also an area in front of a line drawn from the end of the wall to the boundary of the property. In the diagram below, neither extension shown would be permitted development - they both extend beyond a wall forming a principal elevation that fronts a highway.

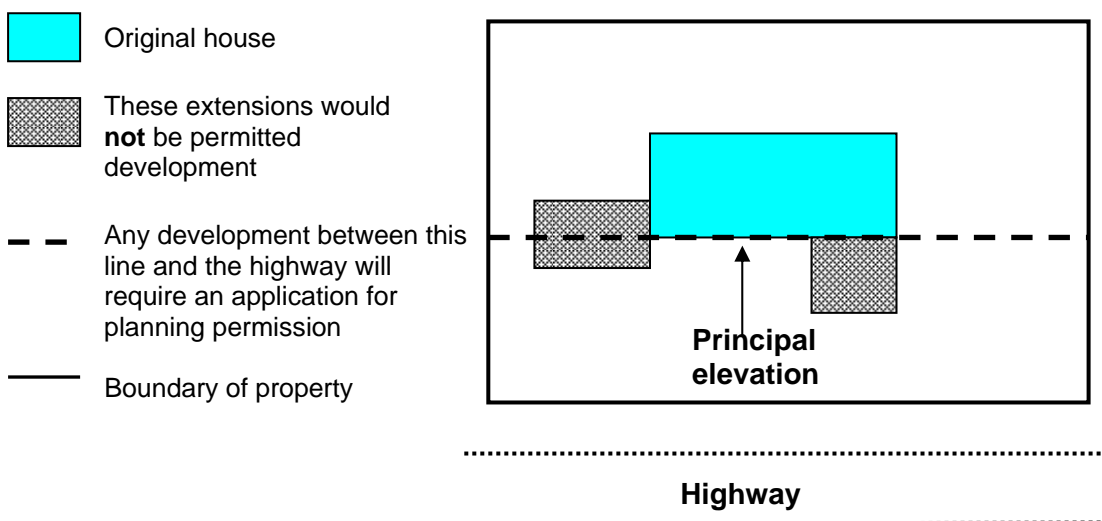

The principal elevation could include more than one wall facing in the same direction - for example, where there are large bay windows on the front elevation, or where there is an 'L' shaped frontage. In such cases, all such walls will form the principal elevation and the line for determining what constitutes 'extends beyond a wall' will follow these walls.

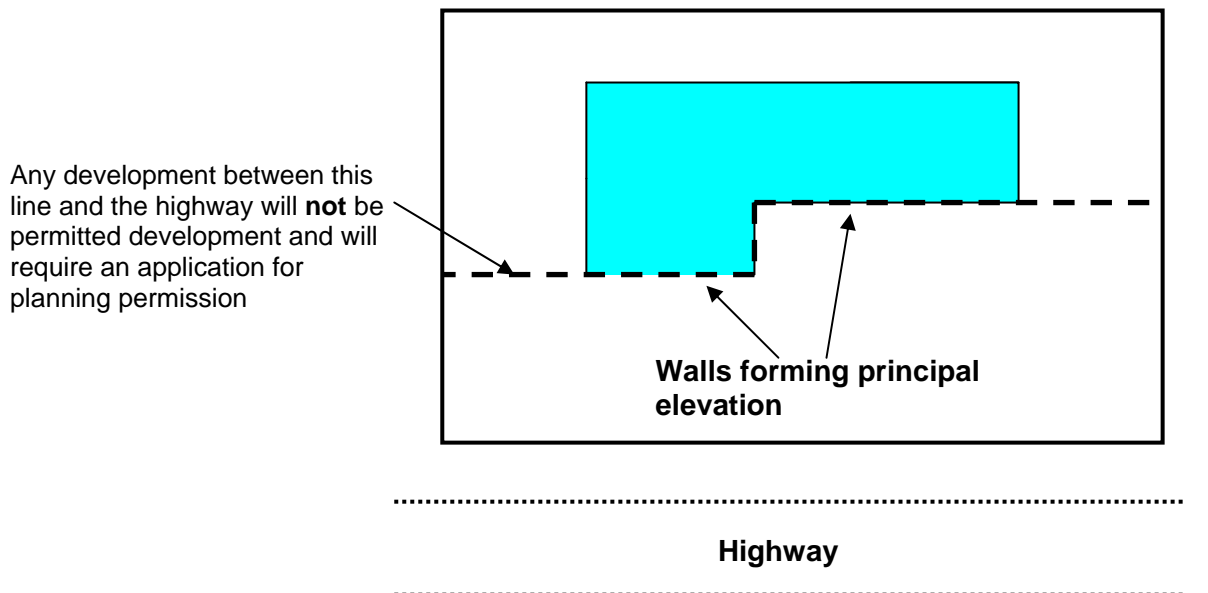
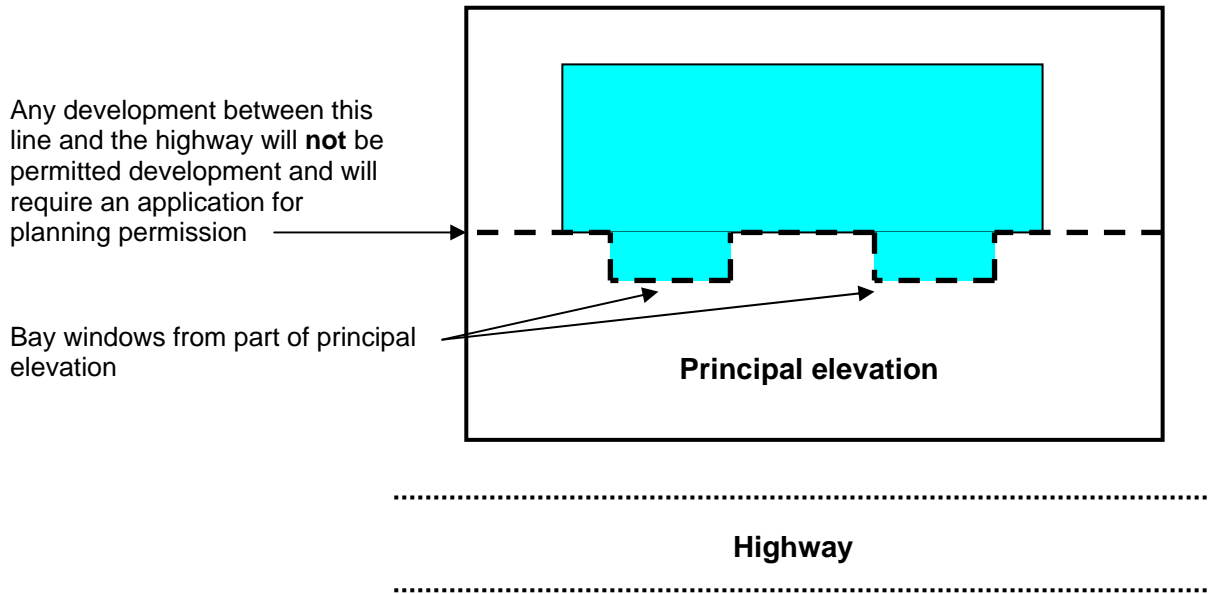

If a house lies on a corner plot where a side elevation also fronts a highway, there will be an additional restriction on permitted development to the side of the house:

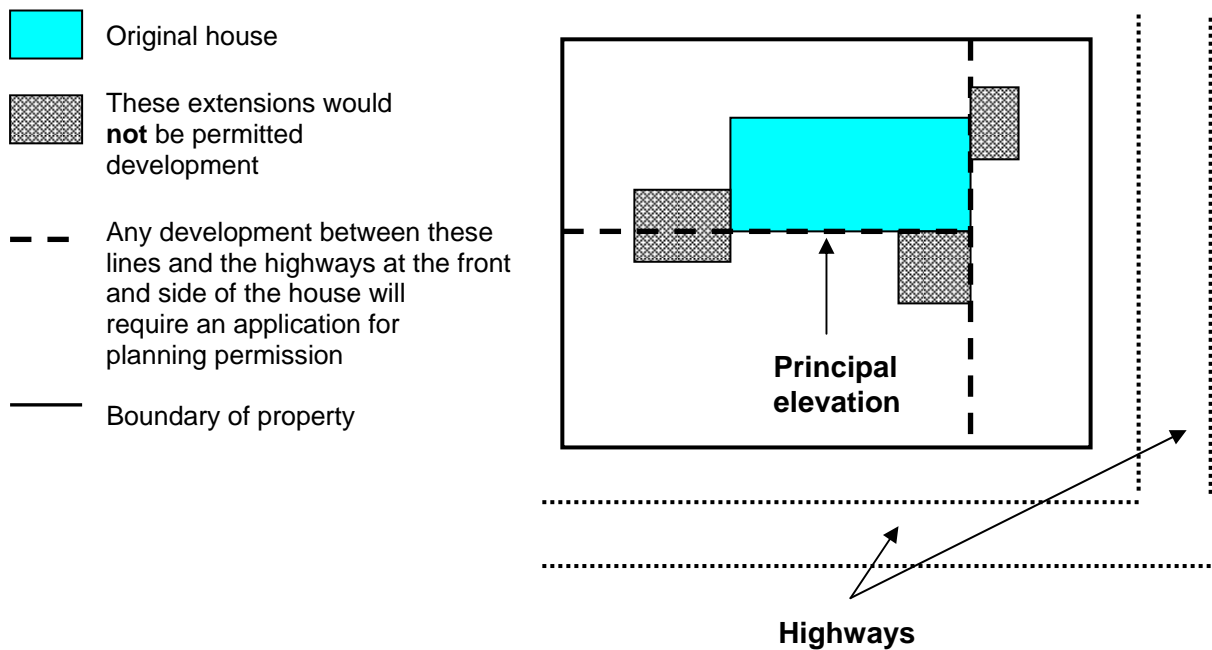

A highway will usually include public roads (whether adopted or not) as well as public footpaths and bridleways, but would not include private driveways. The extent to which an elevation of a house fronts a highway will depend on factors such as:

- (i) the angle between the elevation of the house and the highway. If that angle is more than 45 degrees, then the elevation will not be fronting a highway;
- (ii) the distance between the house and the highway - in cases where that distance is substantial, it is unlikely that a building can be said to 'front' the highway. The same may be true where there is a significant intervening area of land in different ownership or use between the boundary of the curtilage of the house concerned and the highway.

- (e) ***the enlarged part of the dwellinghouse would have a single storey and:***
- (i) ***extend beyond the rear wall of the original dwellinghouse by more than four metres in the case of a detached dwellinghouse, or three metres in the case of any other dwellinghouse or***
  - (ii) ***exceed four metres in height***

A single-storey extension must not extend beyond the rear of the original house by more than four metres if a detached house, or by more than three metres in any other case. In both cases, the total height of the extension must not be more than four metres. The rear wall or walls of a house will be those which are directly opposite the front of the house.

Measurement of the extension beyond the rear wall should be made from the base of the rear wall of the original house to the outer edge of the wall of the extension (not including any guttering or barge boards).

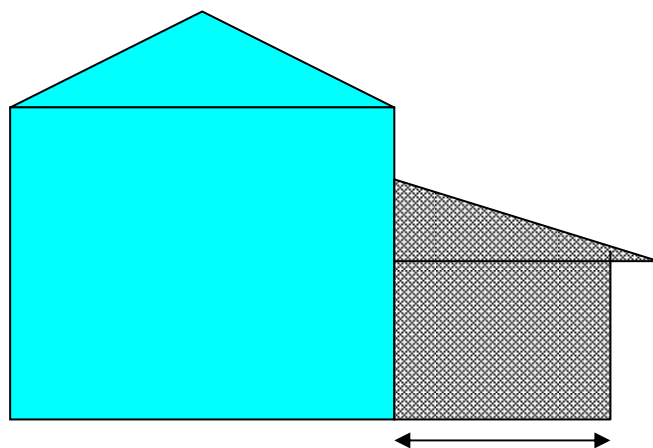

Measurement of 'extend beyond a rear wall' when the extension is directly attached to the rear wall



Where the original rear wall of a house is stepped, then each of these walls will form 'the rear wall of the original dwelling house'. In such cases, the limits on extensions apply to any of the rear walls being extended beyond. In the example below showing a plan of a semi-detached house with an original 'stepped' rear, each of the extensions (shaded) would meet the requirements for a single story extension as they do not extend more than three metres beyond the rear wall:

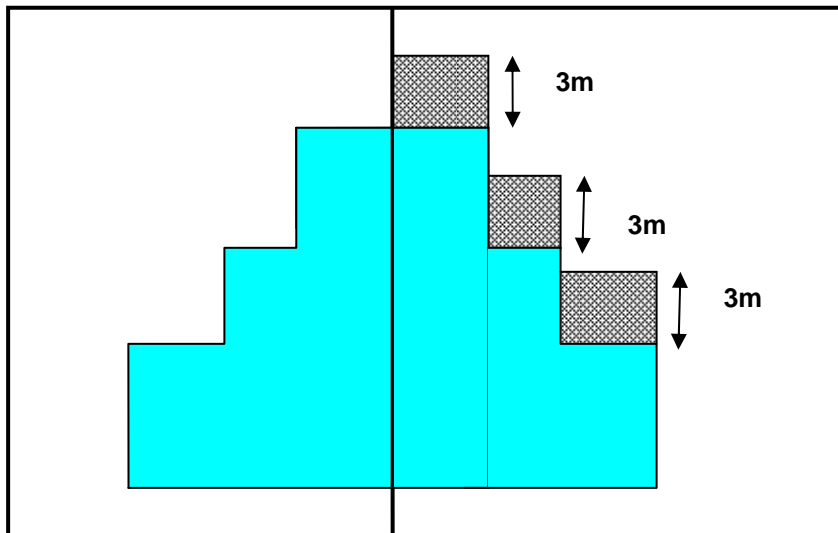

However, the extension shown below would **not** meet the requirements for permitted development. In the case of rear walls 'A' and 'B', the extension goes more than three metres beyond those walls:

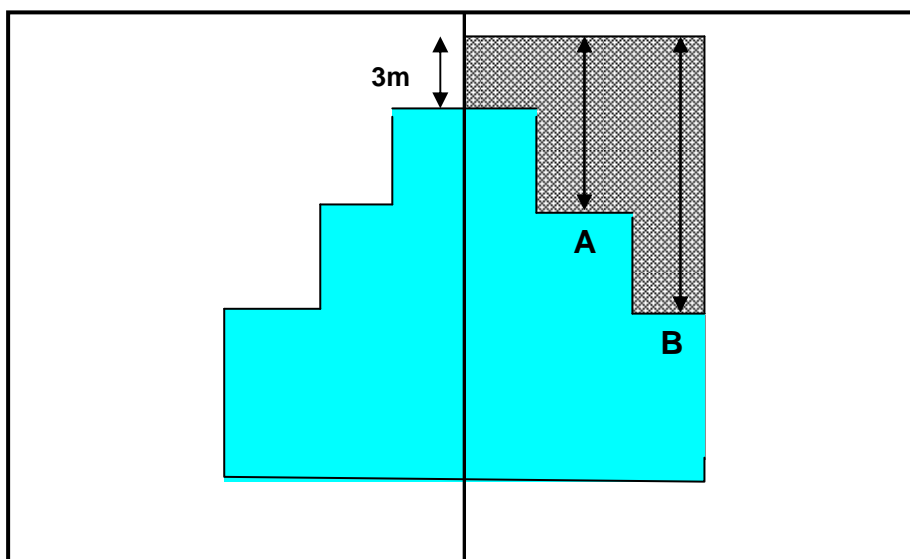

## Side wall extensions extending beyond rear walls

An extension on a side wall that extends beyond a rear wall, but is not attached to a rear wall will be subject to the restrictions that apply to rear walls as well the restrictions on side walls (these are covered under section **(h)** of the rules- see below). So in the example below, the extension is limited to three metres beyond the rear wall of the semi-detached dwelling house as well as being restricted by the limits set for extensions from side walls (i.e. the extension can be no more than half width of house, single storey, and maximum of four metres high).

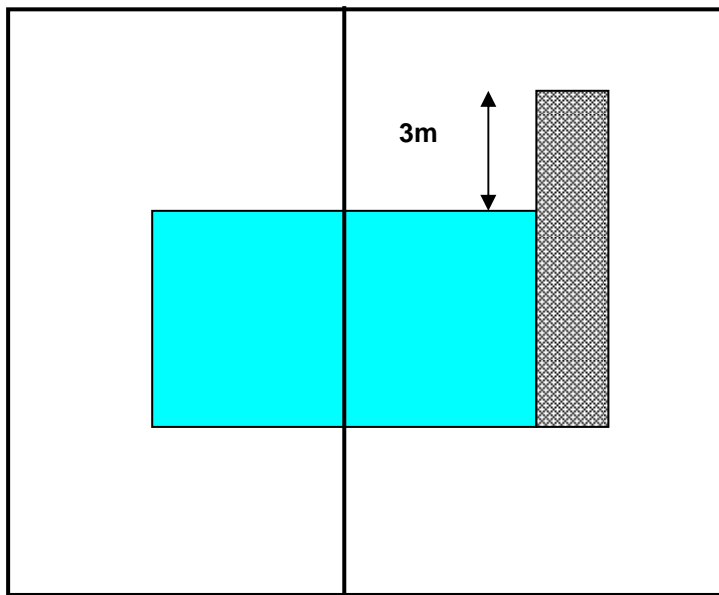

- (f) ***the enlarged part of the dwellinghouse would have more than one storey and:***
- (i) ***extend beyond the rear wall of the original dwellinghouse by more than three metres or***
  - (ii) ***be within seven metres of any boundary of the curtilage of the dwellinghouse opposite the rear wall of the dwellinghouse***

The term 'more than one storey' applies to the part of the house being enlarged through permitted development. This could either be a two storey extension to a house, or might comprise the addition of a storey onto an existing part of the house - for example, the addition of a second storey onto an existing single storey part of the house. The enlarged part of the house must not extend beyond the rear wall by more than three metres if it is to qualify as permitted development. Measurement of the extension beyond the rear wall should be made from the base of the rear wall of the original house that the enlargement extends beyond. Again, this limit applies to any rear wall being built out from (see diagrams under (e) above).

The limits applying to an enlargement of a house by more than one storey will apply in all cases where the enlarged part of the dwelling house includes **any** part that is of more than one storey. So the following, showing a side view of a *detached* house, would **not** be permitted development - the extended part of the house includes more than one storey and the ground floor part extends by than three metres from the rear wall of the house:

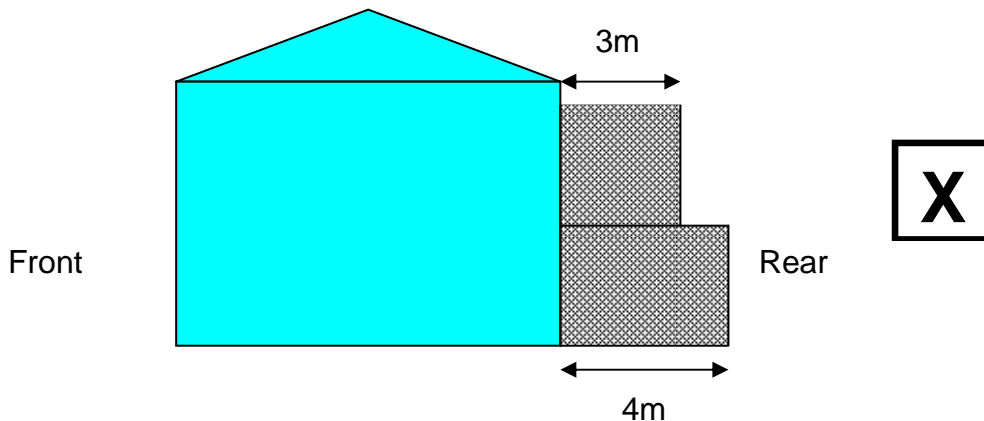

Similarly, if a *detached* house has an existing, single storey, ground floor extension that was not part of the original house and which extended beyond the rear wall by more than three metres, then it would not be possible to add an additional first floor extension above this without an application for planning permission - because the enlarged part of the house would then consist of more than one storey and would extend beyond a rear wall by more than three metres:

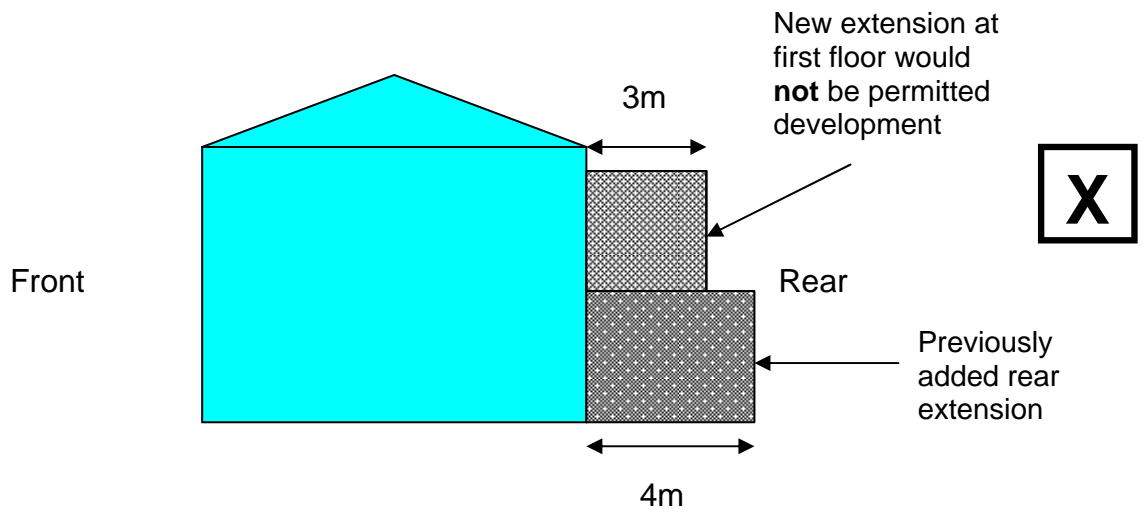

In addition, where the extension or enlarged part of the house has more than one storey, it must be a minimum of seven metres away from the boundary of the land surrounding any house opposite. For example:

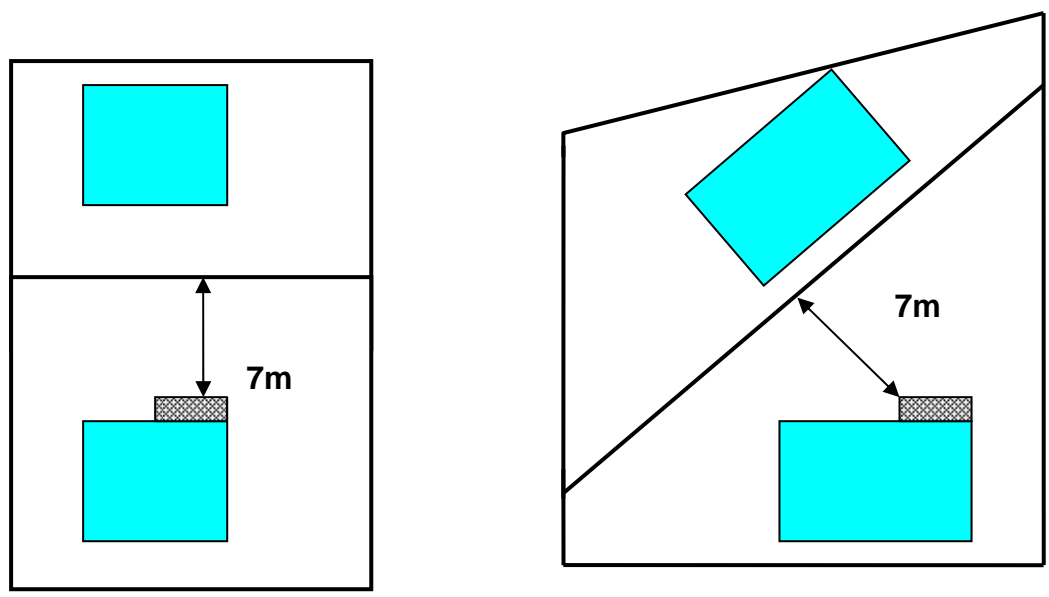

**(g) *the enlarged part of the dwellinghouse would be within two metres of the boundary of the curtilage of the dwellinghouse, and the height of the eaves of the enlarged part would exceed three metres***

Where **any** part of a proposed extension to a house is within two metres of the boundary of the land surrounding the property, then the maximum height of the eaves that is allowed for **all parts** of the proposal is three metres.

Guidance on measurement of eaves is covered under section **(c)** above.

- (h) ***the enlarged part of the dwellinghouse would extend beyond a wall forming a side elevation of the original dwellinghouse, and would:***
- (i) ***exceed four metres in height***
  - (ii) ***have more than one storey or***
  - (iii) ***have a width greater than half the width of the original dwellinghouse***

A wall forming a side elevation of a house will be any wall that cannot be identified as being a front wall or a rear wall. Houses will often have more than two side elevation walls - for example:

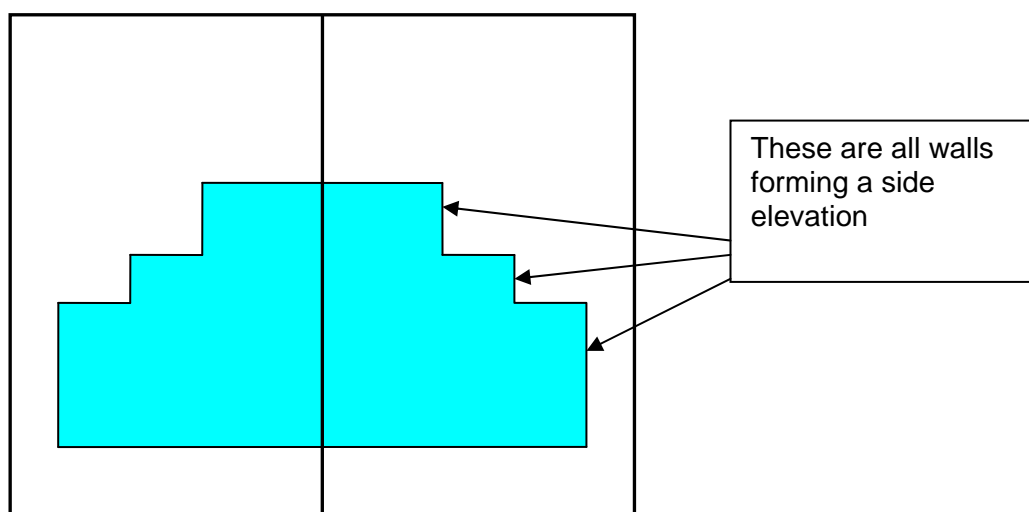

Where an extension is beyond **any** side wall, the restrictions in **(h)** will apply. Any extension can only be a single storey, is limited to four metres in height and can only be half the width of the original house. The width of the original house should be calculated at its widest point.

### **Rear and side extensions**

Where an extension fills the area between a side elevation and a rear wall, then the restrictions on extensions beyond rear walls and side walls will apply. The extension must:

- (i) extend no more than three metres beyond the rear wall (or no more than four metres in the case of a detached house)
- (ii) be a single storey and must not exceed four metres in height
- (iii) have a total width that does not exceed more half the width of the house.

For example:

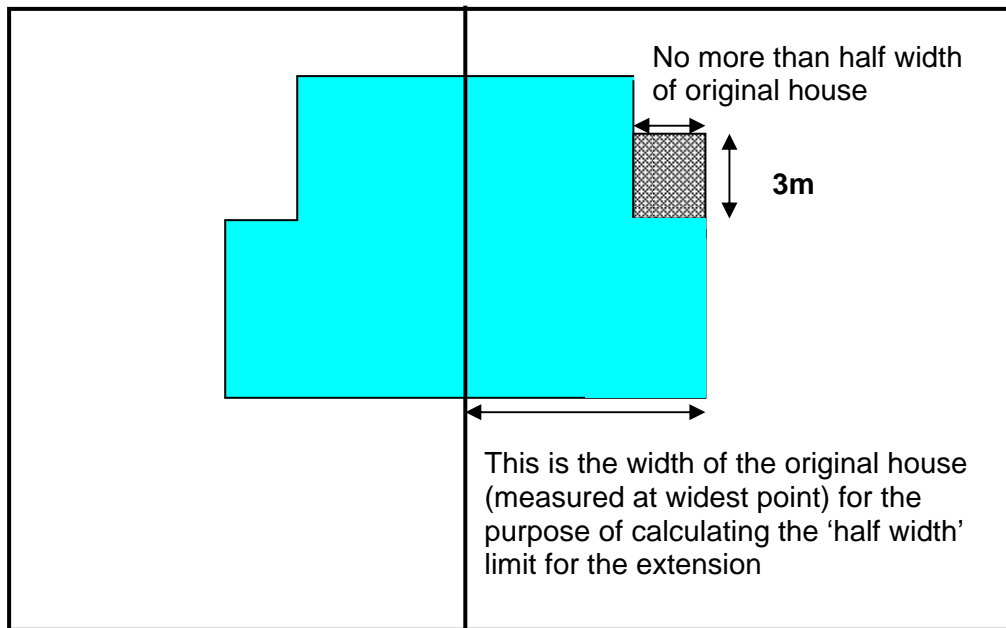

In the following example, although the extension is less than half the width of the original house and extends beyond the rear wall at 'A' by only three metres, it extends beyond the rear wall 'B' by more than three metres. It would therefore **not** be permitted development and will require an application for planning permission.

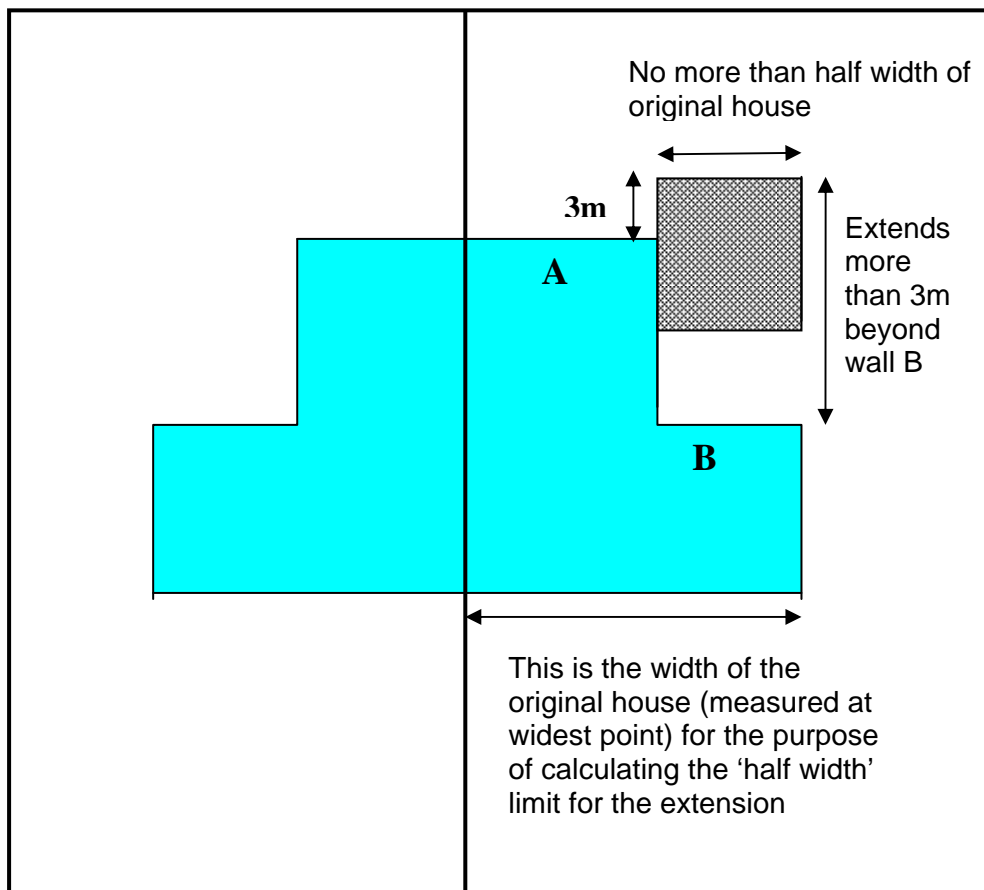

In other cases, an extension may comprise both elements of a rear and side extension. Examples could include:

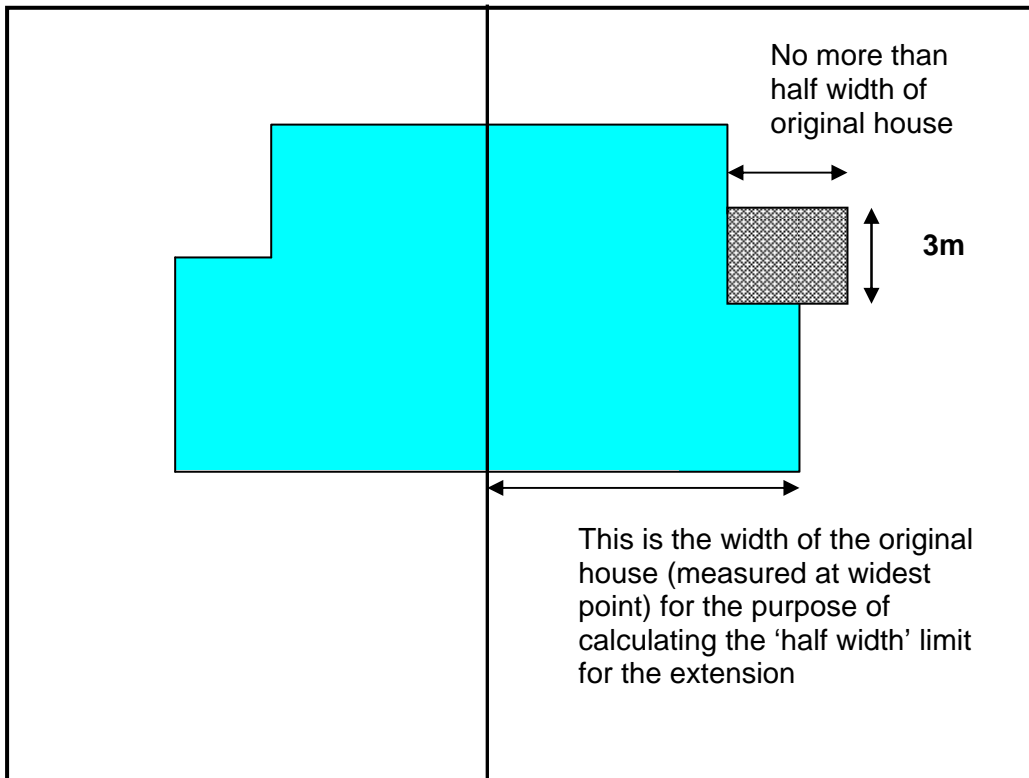
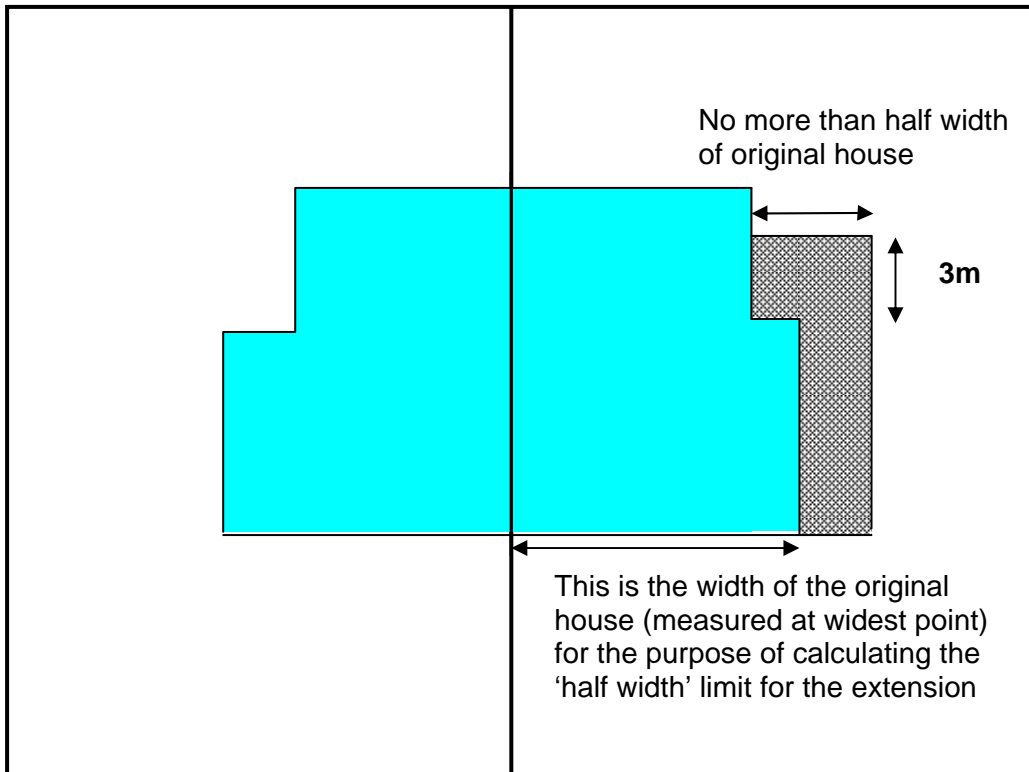



In the two examples above, the extensions would need to meet the relevant criteria for side and rear extensions i.e.:

- (i) the extension must extend no more than three metres beyond the rear wall
- (ii) it can only be a single storey and cannot exceed four metres in height
- (iii) the width of that part of the extension cannot exceed more half the width of the house (measured at its widest point).

The following examples, however, would **not** be permitted development. In each case, the extension extends beyond a side wall and is more than half the width of the original house. An application for planning permission would therefore be required.

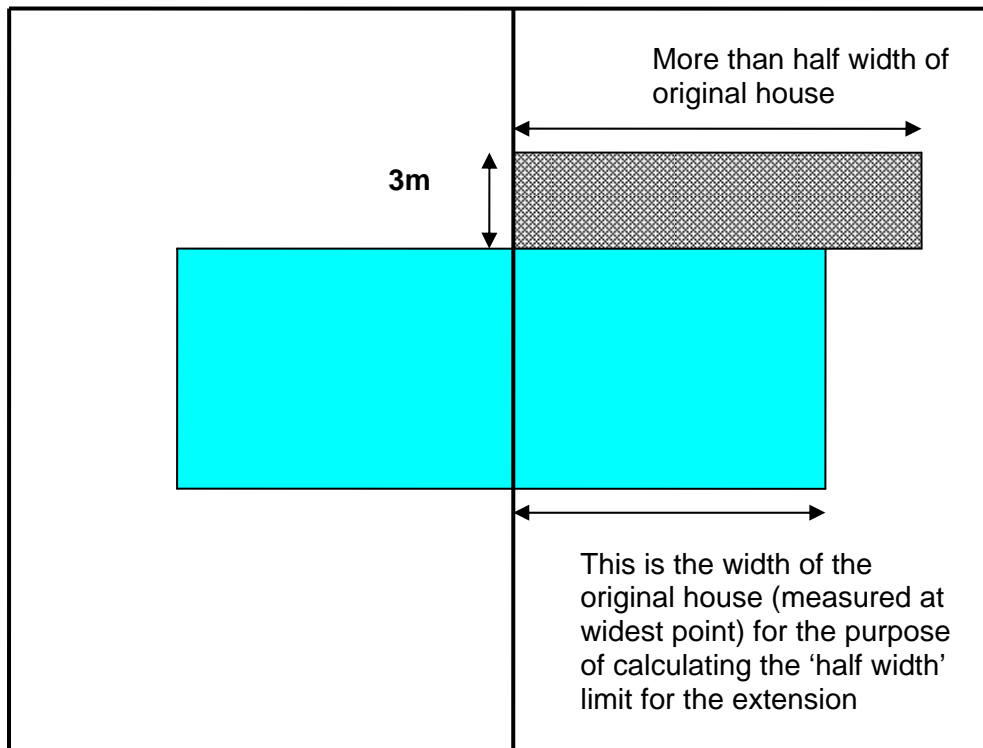

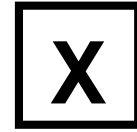
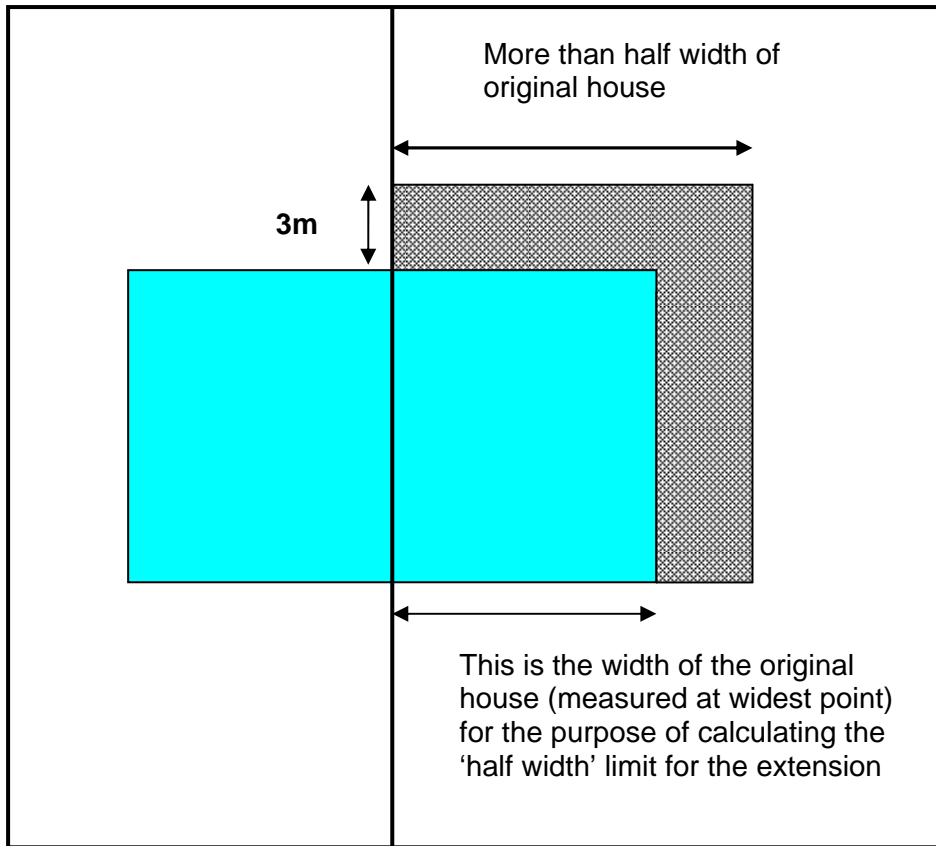

In some situations, it may be that permitted development is undertaken in separate stages, for example, a side extension may be built first, and then a rear extension added at a later date. For example:

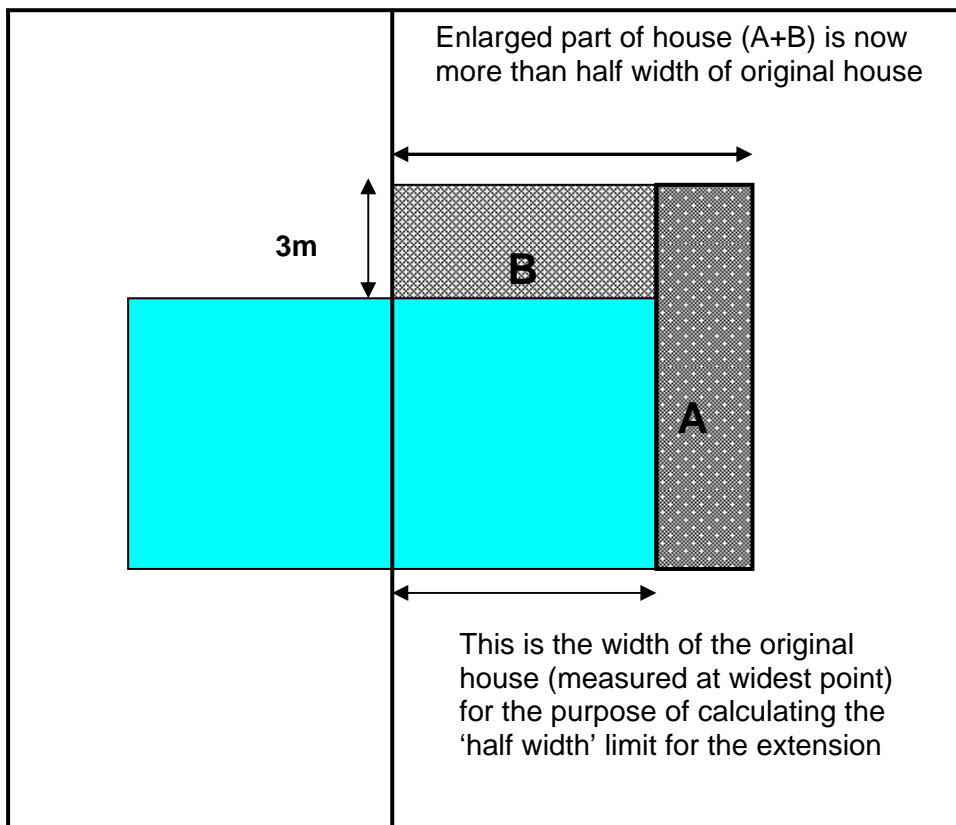

In the example above, if the side extension (**A**) was built first, it would meet the requirement for being no more than half of the width of the original house. However, the later addition of the rear extension (**B**) would mean that the total width would be more than half the width of the house. The rear extension would therefore require an application for planning permission.

The next example would be permitted development. The original side extension (**A**) extends beyond a side wall by no more than half the width of the original house and would be permitted development (subject to meeting the other rules that are relevant under Class A). If the rear extension (**B**) is added at a later date, it has no effect on the width of the side extension (it does not join it). The enlarged part of the house therefore continues to be less than half the width of the house and therefore permitted development.

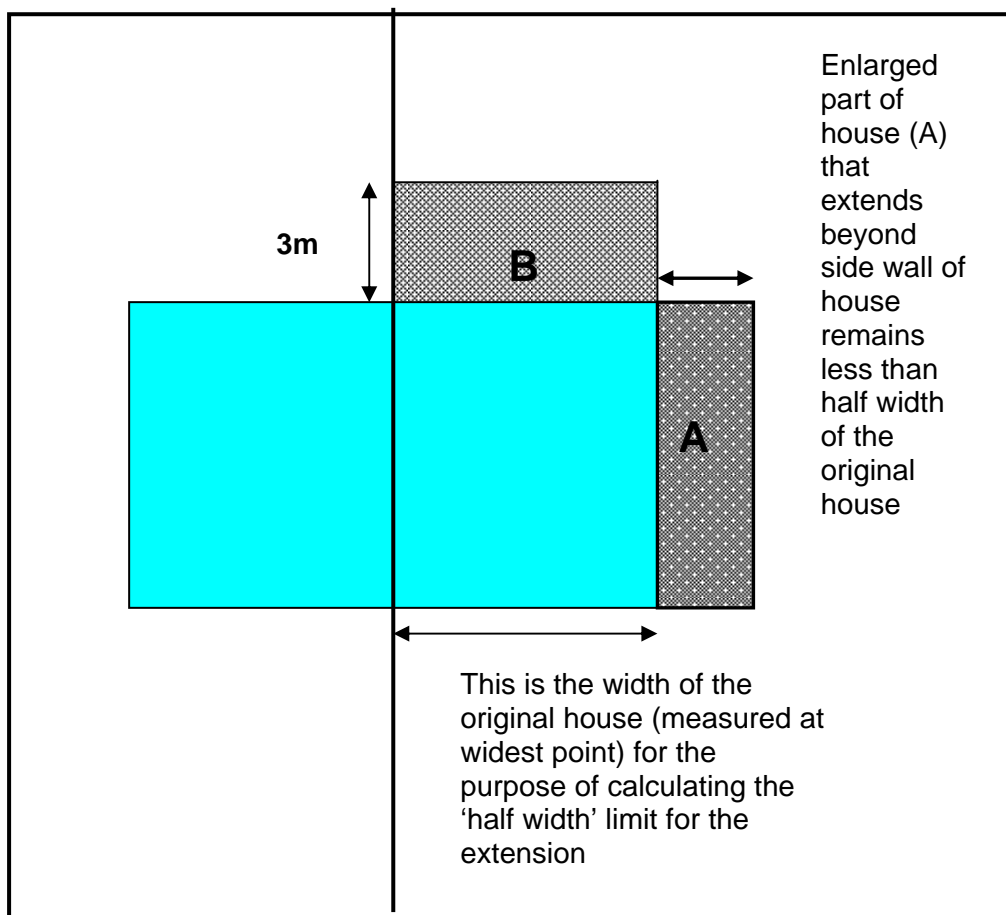

**or**

**(i) it would consist of or include:**

- (i) the construction or provision of a veranda, balcony or raised platform**
- (ii) the installation, alteration or replacement of a microwave antenna**
- (iii) the installation, alteration or replacement of a chimney, flue or soil and vent pipe or**
- (iv) an alteration to any part of the roof of the dwellinghouse.**

Verandas, balconies and raised platforms are not permitted development and will require planning permission.

A veranda is usually defined as a gallery, platform, or balcony, usually roofed and often partly enclosed, extending along the outside of a building at ground level.

A balcony is defined as a platform with a rail, balustrade or parapet projecting outside an upper storey of a building. A 'Juliet' balcony, where there is no platform and therefore no external access would normally be permitted development.

A raised platform is any platform with a height greater than 300 millimetres and will include roof terraces.

Although the items set out in (i), (ii), (iii) and (iv) are not permitted development under Class A of the rules, some may be permitted development under other Classes subject to the limitations and conditions set out in those classes:

Class E covers provision of a 'building' within the area around the house required for a purpose incidental to the enjoyment of the house. A '*Building*' - includes any part of a building and includes any structure or erection - and would include platforms (for example garden decking) less than 300mm high.

Class H covers the installation, alteration or replacement of a microwave antenna.

Class G covers the installation, alteration or replacement of a chimney, flue or soil and vent pipe.

Class B covers enlargement of houses through alterations or additions to the roof and Class C covers other alterations to the roof of a house.

Where an extension to a house under Class A includes works that would require an alteration to the existing roof of the house (eg where the roof of the extension joins the existing roof), the alterations to the existing roof of the house will need to meet the requirements of Class B or C (as appropriate) in order to be permitted development.

**A.2** *In the case of a dwellinghouse on article 1(5) land, development is not permitted by Class A if:*

- (a)** *it would consist of or include the cladding of any part of the exterior of the dwellinghouse with stone, artificial stone, pebble dash, render, timber, plastic or tiles*
- (b)** *the enlarged part of the dwellinghouse would extend beyond a wall forming a side elevation of the original dwellinghouse or*
- (c)** *the enlarged part of the dwellinghouse would have more than one storey and extend beyond the rear wall of the original dwellinghouse*

This section of the rules sets out additional restrictions for National Parks, the Broads, areas of outstanding natural beauty, conservation areas, and land within World Heritage Sites. In these areas:

- the cladding of any part of a house, whether it be the original house or any enlargement is not permitted development and requires an application for planning permission
- extensions beyond any side wall are not permitted development in these areas
- an extension from a rear wall is not permitted development if it results in an enlarged area of the house that has more than one storey.

## **Conditions**

**A.3** *Development is permitted by Class A subject to the following conditions:*

- (a)** *the materials used in any exterior work (other than materials used in the construction of a conservatory) shall be of a similar appearance to those used in the construction of the exterior of the existing dwellinghouse*

The condition above is intended to ensure that any works to enlarge, alter or improve a house result in an appearance that minimises visual impact and is sympathetic to existing development. This means that the materials used should be of similar visual appearance to those in the existing house, but does not mean that they need to be the same materials. For example:

- the external walls of an extension should be constructed of materials that provide a similar visual appearance - for example in terms of colour and style of brick used - to the materials used in existing house walls

- a pitched roof on an extension should be clad in tiles that give a similar visual appearance to those used on the existing house roof. Again, colour and style will be important considerations; flat roofs will not normally have any visual impact and so the need for materials of similar appearance should not apply
- it may be appropriate to include new PVC double glazed windows in an extension even if there are no such windows in the existing house. What is important is that they give a similar visual appearance to those in the existing house, for example in terms of their overall shape, and the colour and size of the frames.

This condition does not apply to conservatories.

**b) any upper-floor window located in a wall or roof slope forming a side elevation of the dwellinghouse shall be:**

- (i) obscure-glazed and**
- (ii) non-opening unless the parts of the window which can be opened are more than 1.7 metres above the floor of the room in which the window is installed**

This condition requires upper-floor windows in any part of the side of a house to be obscure glazed. Glazing to provide privacy is normally rated on a scale of 1-5, with 5 providing the most privacy. To be permitted development, side windows should be obscure glazed to minimum of level 3. Obscure glazing does not include one-way glass.

Where such a window is on a staircase or landing (i.e. not in a room) the 1.7 metre measurement should be made from the stair or point on a landing immediately below the centre of the window, upwards to the opening part of the window.

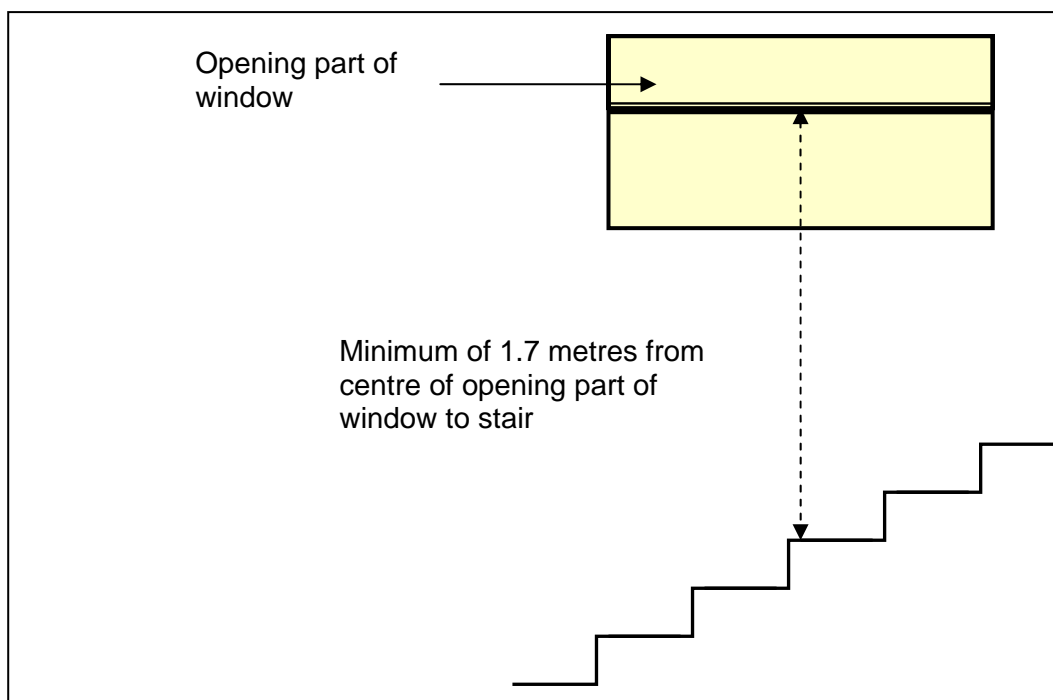

- (c) *where the enlarged part of the dwellinghouse has more than one storey, the roof pitch of the enlarged part shall, so far as practicable, be the same as the roof pitch of the original dwellinghouse*

For example:

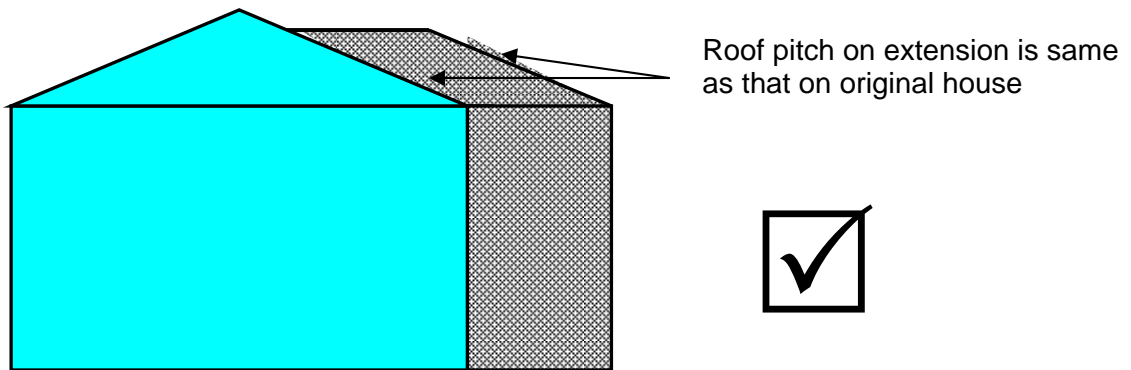

# Class B

This provides permitted development rights for the enlargement of a house consisting of an addition or alteration to its roof.

Under Class B the following limits and conditions apply:

**B.1 Development is not permitted by Class B if:**

**(a) any part of the dwellinghouse would, as a result of the works, exceed the height of the highest part of the existing roof**

Additions and alterations made to a roof to enlarge a house (e.g. a loft conversion or the replacement of an existing flat roof with a pitched roof) will only be permitted development if no part of the house once enlarged exceeds the height of the highest part of the roof of the existing house. If it does, planning permission will be required.

The highest part of the roof of the existing dwelling house will be the height of the ridge line of the main roof (even though there may be other ridge lines at a lower level) or the height of the highest roof where roofs on a building are flat.

Chimneys, firewalls, parapet walls and other protrusions above the main roof ridge line should not be taken into account when considering the height of the highest part of the roof of the existing house.

**(b) any part of the dwellinghouse would, as a result of the works, extend beyond the plane of any existing roof slope which forms the principal elevation of the dwellinghouse and fronts a highway**

The effect of this is that dormer windows as part of a loft conversion, or any other enlargement of the roof space, are not permitted development on a principal elevation that fronts a highway and will therefore require an application for planning permission. Roof-lights in a loft conversion on a principal elevation may however be permitted development as long as they meet the requirements set out under Class C (see below).

In most cases, the principal elevation will be that part of the house which faces (directly or at an angle) the main highway serving the house (the main highway will be the one that sets the postcode for the house concerned). It will usually contain the main architectural features such as main bay windows or a porch serving the main entrance to the house. Usually, but not exclusively, the principal elevation will be what is understood to be the front of the house.

There will only be one principal elevation on a house. Where there are two elevations which may have the character of a principal elevation (for example, on a corner plot), a view will need to be taken as to which of these forms the principal elevation.



The principal elevation could include more than one roof slope facing in the same direction - for example, where there are large bay windows on the front elevation, or where there is an 'L' shaped frontage. In such cases, all such roof slopes will form the principal elevation and the line for determining what constitutes 'extends beyond the plane of any existing roof slope' will follow these slopes (see guidance on Class A **(d)** for an illustration of this).

A highway will usually include public roads (whether adopted or not) as well as public footpaths and bridleways, but would not include private driveways. The extent to which an elevation of a house fronts a highway will depend on factors such as:

- (i) the angle between the elevation of the house and the highway. If that angle is more than 45 degrees, then the elevation will not be fronting a highway;
- (ii) the distance between the house and the highway - in cases where that distance is substantial, it is unlikely that a building can be said to 'front' the highway. The same may be true where there is a significant intervening area of land in different ownership or use between the boundary of the curtilage of the house concerned and the highway.

**(c) *the cubic content of the resulting roof space would exceed the cubic content of the original roof space by more than:***

***(i) 40 cubic metres in the case of a terrace house or***

***(ii) 50 cubic metres in any other case***

**For the purposes of Class B 'resulting roof space' means the roof space as enlarged, taking into account any enlargement to the original roof space, whether permitted by this Class or not.**

To be permitted development any additional roof space created must not increase the volume of the original roof space of the house by more than 40 cubic metres for terraced houses and 50 cubic metres for semi-detached and detached houses. Any previous enlargement to the original roof space in any part of the house must be included in this volume allowance. 'Terrace house' is defined in the legislation under the section 'Interpretation of Part 1' - set out at the end of this guidance.

'Original roof space' will be that roof space in the 'original building' (see 'General Issues' section of this document above for the definition of this).

**(d) *it would consist of or include:***

***(i) the construction or provision of a veranda, balcony or raised platform or***

***(ii) the installation, alteration or replacement of a chimney, flue or soil and vent pipe***

Alterations to the roof of a house for loft conversions involving the creation of balconies are not permitted development and will require planning permission. A balcony is defined as a platform with a rail, balustrade or parapet projecting outside an upper storey of a building. A 'Juliet' balcony, where there is no platform and therefore no external access, would be permitted development. A raised platform is any platform with a height greater than 300 millimetres and would include roof terraces.

Installation, alteration or replacement of chimneys, flues or soil and vent pipes will often be necessary when loft conversions are undertaken. Whilst these are not permitted development under Class B of these rules, they may be permitted development under Class G.

**(e) *the dwellinghouse is on article 1(5) land***

In National Parks, the Broads, areas of outstanding natural beauty, conservation areas, and land within World Heritage Sites, roof extensions are **not** permitted development and will require an application for planning permission.

## **Conditions**

**B.2 *Development is permitted by Class B subject to the following conditions:***

**(a) *the materials used in any exterior work shall be of a similar appearance to those used in the construction of the exterior of the existing dwellinghouse***

This condition is intended to ensure that any addition or alteration to a roof for a loft conversion results in an appearance that minimises visual impact and is sympathetic to the existing house. This means that the materials used should be of similar visual appearance to those in the existing house, but does not mean that they need to be the same materials or match exactly. The visual impacts of the materials used will be the most important consideration. For example:

- the flat roofs of dormer windows will not normally have any visual impact and so the use of materials such as felt, lead or zinc for flat roofs of dormers will therefore be acceptable
- the face and sides of a dormer window should be finished using materials that give a similar visual appearance to existing house. So the materials used for facing a dormer should appear to be of similar colour and design to the materials used in the main roof of the house when viewed from ground level. Window frames should also be similar to those in the existing house in terms of their colour and overall shape.

- (b) other than in the case of a hip-to-gable enlargement, the edge of the enlargement closest to the eaves of the original roof shall, so far as practicable, be not less than 20 centimetres from the eaves of the original roof**

The measurement of 20cm should be made along the original roof slope from the outermost edge of the eaves (the edge of the tiles or slates) to the edge of the enlargement. Any guttering that protrudes beyond the roof slope should not be included in this measurement.

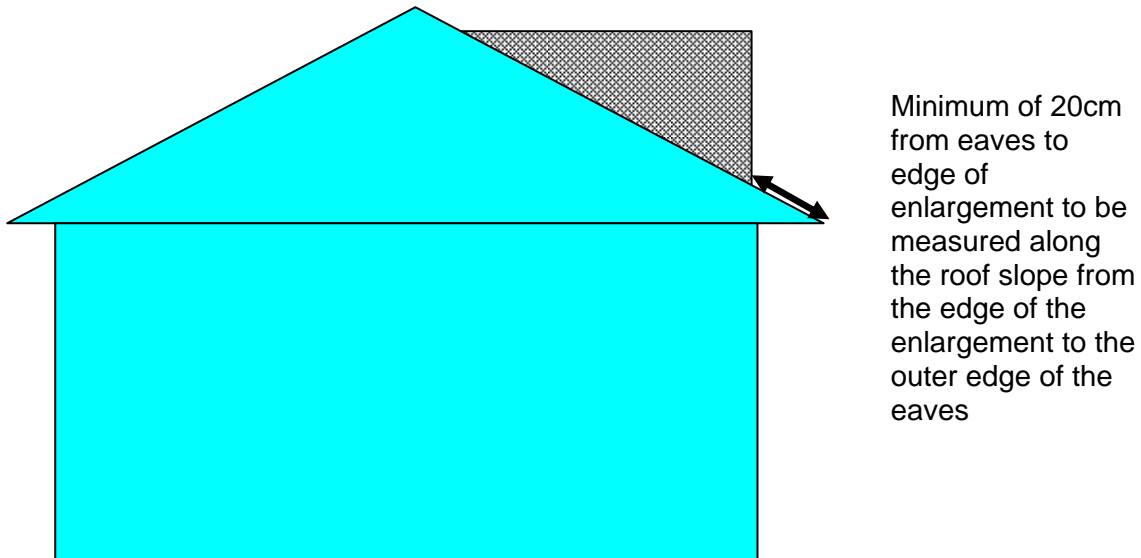

This 20cm set back will be required unless it can be demonstrated that this is not possible due to practical or structural considerations. One circumstance where it will not prove practical to maintain this 20cm distance will be where a dormer on a side extension of a house joins an existing, or proposed, dormer on the main roof of the house.

- (c) any window inserted on a wall or roof slope forming a side elevation of the dwellinghouse shall be:**

**(i) obscure-glazed and**

**(ii) non-opening unless the parts of the window which can be opened are more than 1.7 metres above the floor of the room in which the window is installed**

Windows for a loft extension on a side elevation of a house must be obscure glazed to benefit from permitted development. Glazing to provide privacy is normally rated on a scale of 1-5, with 5 providing the most privacy. To be permitted development, side windows should be obscure glazed to minimum of level 3. Obscure glazed does not include one-way glass.

Where such a window is on a staircase or landing (i.e. not in a room) the 1.7 metre measurement should be made from the stair or point on a landing immediately below the centre of the window, upwards to the opening part of the window (see diagram under Class A - A.3 (b) above).

# Class C

This provides permitted development rights for any other alteration to the roof of a house.

Such alterations will not involve any enlargement of the house, but would, for example, cover the installation of rooflights.

Under Class C the following limits and conditions apply:

**C.1 Development is not permitted by Class C if:**

- (a) ***the alteration would protrude more than 150 millimetres beyond the plane of the slope of the original roof when measured from the perpendicular with the external surface of the original roof***

Any protrusion from a roof, for example, for a rooflight and its frame, will be limited to 150mm:

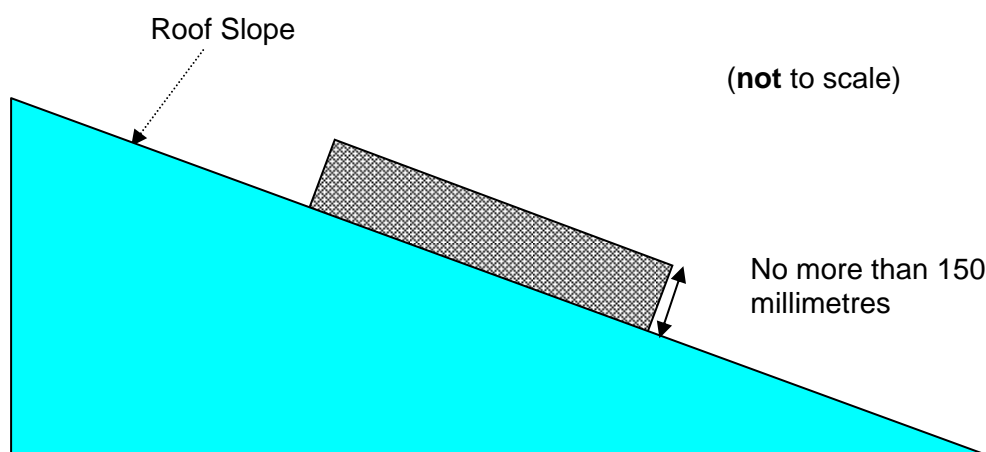

This limitation to projection from the roof plane should not be applied in cases where the roof of an extension to a house that is permitted development under Class A is joined to the roof of the original house. In such cases, the roof of the extension should not be considered as protruding from the original roof.

- (b) ***it would result in the highest part of the alteration being higher than the highest part of the original roof or***
- (c) ***it would consist of or include:***
- (i) ***the installation, alteration or replacement of a chimney, flue or soil and vent pipe, or***

Guidance on these limits is covered under Class B above and will also apply to development under Class C. Note, however, that in the case of Class C, measurement of height is made against the *original* roof and not as in Class B where it is the *existing* roof.

**(ii) the installation, alteration or replacement of solar photovoltaics or solar thermal equipment.**

Although solar photovoltaics and solar thermal equipment (i.e. solar panels) are not permitted development under Class C, they may not require an application for planning permission if they meet the requirements set out under Part 40 of the rules on permitted development.

**Conditions**

***C.2 Development is permitted by Class C subject to the condition that any window located on a roof slope forming a side elevation of the dwellinghouse shall be:***

***(a) obscure-glazed and***

***(b) non-opening unless the parts of the window which can be opened are more than 1.7 metres above the floor of the room in which the window is installed***

Guidance on these conditions is covered under Class B above and will also apply to development under Class C.

# Class D

This provides permitted development rights for the erection of a porch outside any external door of a dwellinghouse.

*Development is not permitted by Class D if:*

- (a) the ground area (measured externally) of the structure would exceed three square metres*
- (b) any part of the structure would be more than three metres above ground level or*
- (c) any part of the structure would be within two metres of any boundary of the curtilage of the dwellinghouse with a highway*

These rules are illustrated on the Planning Portal:

[www.planningportal.gov.uk/uploads/miniguides/porch/porches.html](http://www.planningportal.gov.uk/uploads/miniguides/porch/porches.html)

# Class E

This provides permitted development rights within the area surrounding a house ('the curtilage') for:

- (a) ***any building or enclosure, swimming or other pool required for a purpose incidental to the enjoyment of the dwellinghouse as such, or the maintenance, improvement or other alteration of such a building or enclosure or***
- (b) ***a container used for domestic heating purposes for the storage of oil or liquid petroleum gas***

Class E sets out the rules on permitted development for buildings etc within the area of land surrounding a house (guidance under Class A above (**A.1 (a)**) describes what will be the 'curtilage'). Buildings should not be attached to the house and should be built for purposes incidental to the enjoyment of the house. Paragraph E.4 of Class E indicates that purposes incidental to the enjoyment of the house includes the keeping of poultry, bees, pet animals, birds or other livestock for the domestic needs or personal enjoyment of the occupants of the house.

But the rules also allow, subject to the conditions and limitations below, a large range of other buildings on land surrounding a house. Examples could include common buildings such as garden sheds, other storage buildings, garages, and garden decking as long as they can be properly be described as having a purpose incidental to the enjoyment of the house. A purpose incidental to a dwelling house would not, however, cover normal residential uses, such as separate self-contained accommodation nor the use of an outbuilding for primary living accommodation such as a bedroom, bathroom, or kitchen.

**Under Class E, the following limits and conditions apply:**

***E.1 Development is not permitted by Class E if:***

- (a) ***the total area of ground covered by buildings, enclosures and containers within the curtilage (other than the original dwellinghouse) would exceed 50% of the total area of the curtilage (excluding the ground area of the original dwellinghouse)***

The total area of ground around the house covered by buildings, enclosures and containers must not exceed 50% of the total area of land around the original house. The 50% figure must also take account of any extensions to the original house under Class A of the permitted development rules or any extension to the original house that has been granted planning permission. The 50% limit excludes the area covered by the house as originally built but does include any separate detached buildings built prior to 1948 (e.g. a detached garage).



**(b) any part of the building, enclosure, pool or container would be situated on land forward of a wall forming the principal elevation of the original dwellinghouse**

The guidance on Class A permitted developments - section (d) - describes what will be the principal elevation of a house.

‘Forward of a wall forming the principal elevation’ means that development is not permitted under Class E in any area in front of the principal elevation of a house. It also prevents permitted development anywhere in front of a hypothetical line drawn through the principal elevation to the side boundary of the land surrounding the house. For example:

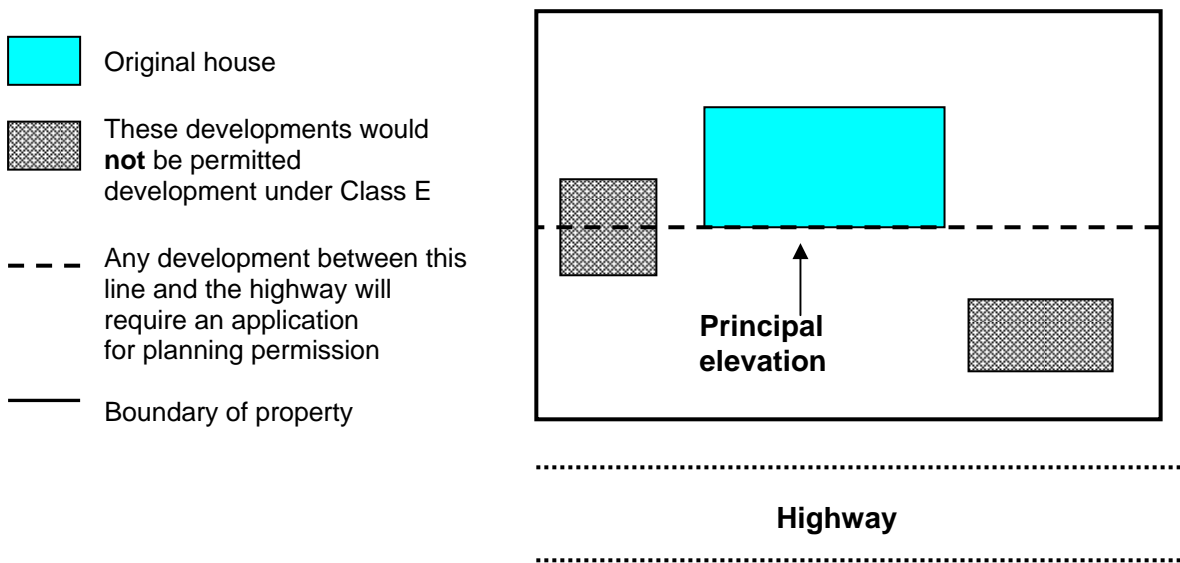

Where the principal elevation comprises more than one wall facing in the same direction, all such walls will form part of the principal elevation and the line for determining what constitutes ‘extends beyond a wall’ will follow these walls:

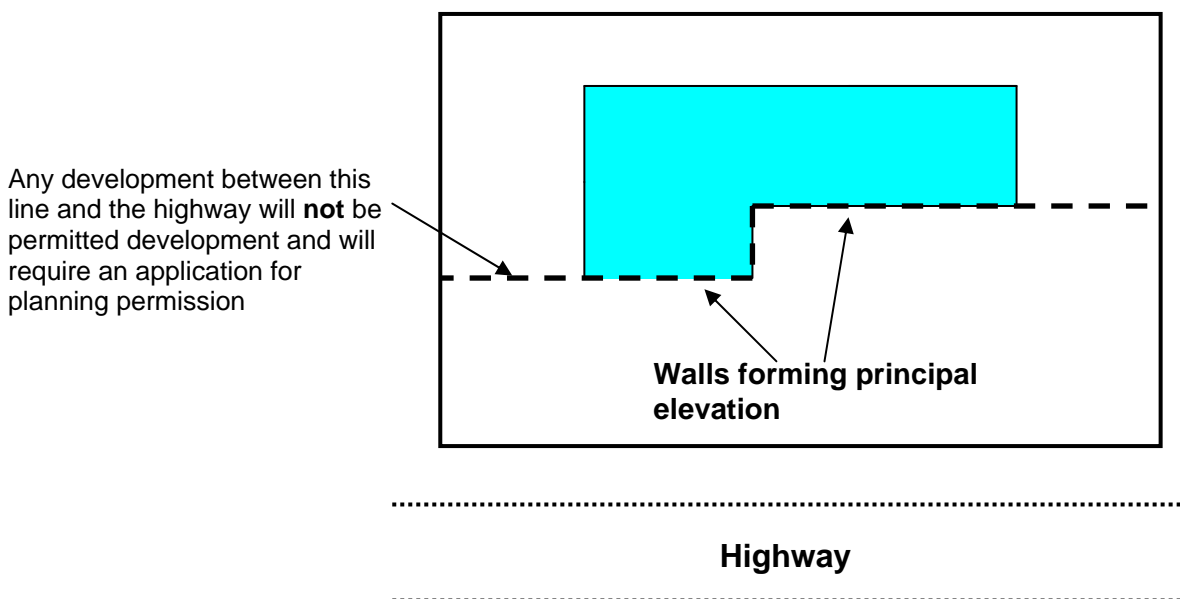

**(c) the building would have more than one storey**

Any buildings within the curtilage can only have one storey. Buildings with more than storey are **not** permitted development and will require an application for planning permission.

**(d) the height of the building, enclosure or container would exceed:**

- (i) four metres in the case of a building with a dual-pitched roof**
- (ii) 2.5 metres in the case of a building, enclosure or container within two metres of the boundary of the curtilage of the dwellinghouse or**
- (iii) three metres in any other case**

The height of the building, enclosure or container should be measured from the ground level immediately adjacent to the building, enclosure, or container to its highest point.

The height limit on a 'dual-pitched roof' of four metres should also be applied to buildings that have 'hipped' roofs (slopes on all four sides)

If **any** part of the building, container or enclosure is within two metres of the boundary of the area around then house, then the height limit for the **whole** development is restricted to 2.5 metres if it is to be permitted development.

**(e) the height of the eaves of the building would exceed 2.5 metres**

The eaves of a building will be the point where the lowest point of a roof slope, or a flat roof, meets the outside wall of the building. The Guidance on Class A above includes examples and further guidance.

Under Class E the maximum height of the eaves on any part of the building (irrespective of total height) is 2.5 metres. For example, on a building with a single-pitched roof, the 2.5 metres eaves limit and three metres maximum height limit would be as shown below:

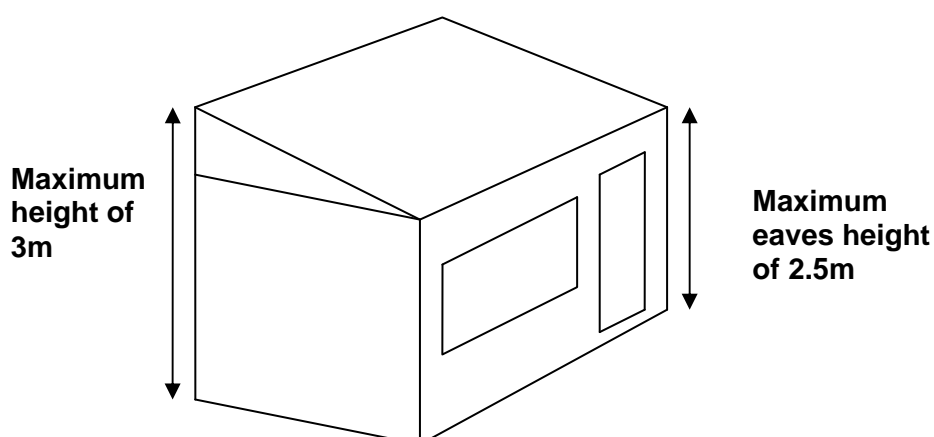

- (f) the building, enclosure, pool or container would be situated within the curtilage of a listed building**

An application for planning permission will be required for any building, enclosure, pool or container that would be situated on land surrounding a listed building.

- (g) it would include the construction or provision of a veranda, balcony or raised platform**

Verandas, balconies and raised platforms are not permitted development under Class E.

A raised platform is defined as any platform that has a height of more than 300mm. Garden decking will therefore be permitted development under Class E subject to it not exceeding this 300mm height limit and subject to the other limits and conditions under this Class.

- (h) it relates to a dwelling or a microwave antenna**

Class E covers buildings that are for a purpose incidental to a dwelling. Class E does not provide permitted development rights for works related to a house (e.g. extensions to a house) which are covered by other Classes of the rules on permitted development. Permitted development rights for microwave antenna are covered under Class H of the rules.

- (i) the capacity of the container would exceed 3,500 litres**

A container with a capacity greater than 3,500 litres will not be permitted development and will require an application for planning permission.

**E.2 In the case of any land within the curtilage of the dwellinghouse which is within:**

- (a) a World Heritage Site**
- (b) a National Park**
- (c) an area of outstanding natural beauty or**
- (d) the Broads**

**development is not permitted by Class E if the total area of ground covered by buildings, enclosures, pools and containers situated more than 20 metres from any wall of the dwellinghouse would exceed 10 square metres**

The effect of this limitation is to restrict the amount of permitted development for buildings, enclosures, pools and containers located more than 20 metres away from any wall of the house. The total area of ground which may be covered by buildings etc more than 20 metres from any wall of a house is 10 square metres.

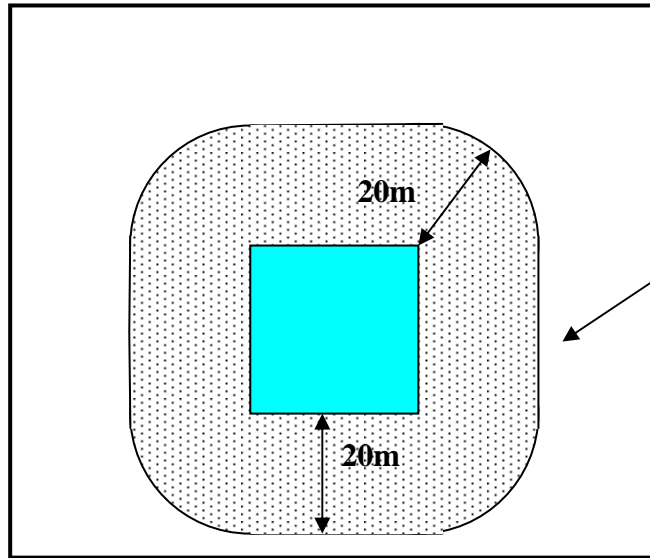

Maximum total area of ground that can be covered by buildings, enclosures, pools or containers in this unshaded area is 10 square metres

**E.3** *In the case of any land within the curtilage of the dwellinghouse which is article 1(5) land, development is not permitted by Class E if any part of the building, enclosure, pool or container would be situated on land between a wall forming a side elevation of the dwellinghouse and the boundary of the curtilage of the dwellinghouse*

This additional restriction applies for land surrounding a house in National Parks, the Broads, areas of outstanding natural beauty, conservation areas, and within World Heritage Sites. In these areas, buildings, enclosures, pools or containers sited on land between a side wall and the boundary of the land surrounding the house are not permitted development:

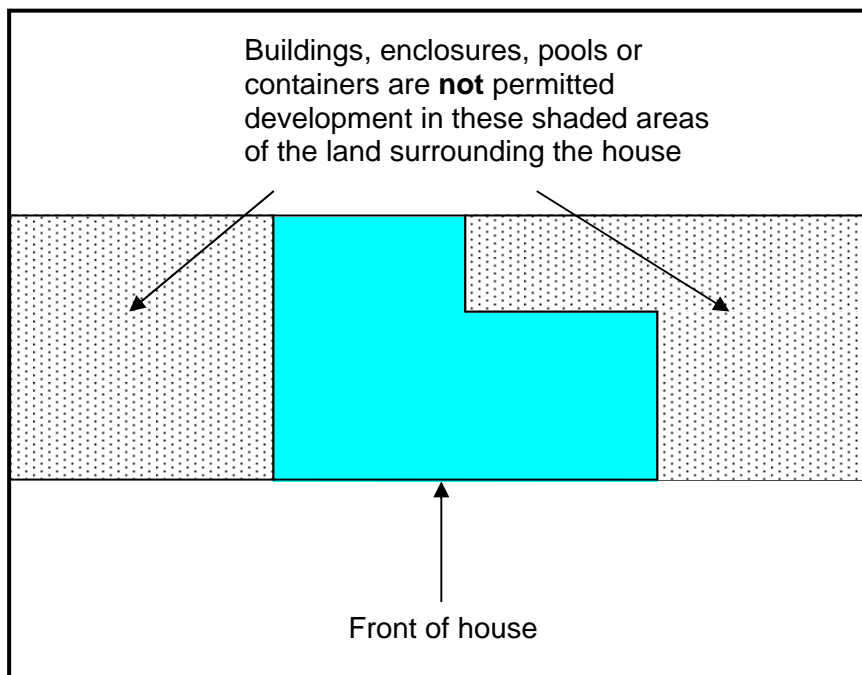

## Interpretation of Class E

***E.4 For the purposes of Class E, 'purpose incidental to the enjoyment of the dwellinghouse as such' includes the keeping of poultry, bees, pet animals, birds or other livestock for the domestic needs or personal enjoyment of the occupants of the dwellinghouse***

# Other classes under Part 1

## Class F

This provides permitted development rights within the area of land surrounding the house ('the curtilage') for:

- (a) *the provision of a hard surface for any purpose incidental to the enjoyment of the dwellinghouse as such or*
- (b) *the replacement in whole or in part of such a surface*

### Conditions

*F.1 Development is permitted by Class F subject to the condition that where:*

- (a) *the hard surface would be situated on land between a wall forming the principal elevation of the dwellinghouse and a highway and*
- (b) *the area of ground covered by the hard surface, or the area of hard surface replaced, would exceed five square metres*

*either the hard surface shall be made of porous materials, or provision shall be made to direct run-off water from the hard surface to a permeable or porous area or surface within the curtilage of the dwellinghouse*

Communities and Local Government have produced separate guidance on permeable paving. This can be found at:

[www.communities.gov.uk/documents/planningandbuilding/pdf/pavingfrontgardens.pdf](http://www.communities.gov.uk/documents/planningandbuilding/pdf/pavingfrontgardens.pdf)

## Class G

This provides permitted development rights for the installation, alteration or replacement of a chimney, flue or soil and vent pipe on a dwellinghouse.

***G.1 Development is not permitted by Class G if:***

- (a) the height of the chimney, flue or soil and vent pipe would exceed the highest part of the roof by 1 metre or more or***
- (b) in the case of a dwellinghouse on article 1(5) land, the chimney, flue or soil and vent pipe would be installed on a wall or roof slope which:***
  - (i) fronts a highway, and***
  - (ii) forms either the principal elevation or a side elevation of the dwellinghouse***

The guidance on the rules under Class A provides advice on the terms 'highest part of the roof', 'fronts a highway' and 'principal' and 'side elevations'.

## Class H

This provides permitted development rights for the installation, alteration or replacement of a microwave antenna, such as a satellite dish, on a dwellinghouse or within the curtilage of a dwellinghouse.

***H.1 Development is not permitted by Class H if:***

- (a) it would result in the presence on the dwellinghouse or within its curtilage of:***
  - (i) more than two antennas***
  - (ii) a single antenna exceeding 100 centimetres in length***
  - (iii) two antennas which do not meet the relevant size criteria***
  - (iv) an antenna installed on a chimney, where the length of the antenna would exceed 60 centimetres***
  - (v) an antenna installed on a chimney, where the antenna would protrude above the chimney or***
  - (vi) an antenna with a cubic capacity in excess of 35 litres***
- (b) in the case of an antenna to be installed on a roof without a chimney, the highest part of the antenna would be higher than the highest part of the roof***

- (c) in the case of an antenna to be installed on a roof with a chimney, the highest part of the antenna would be higher than the highest part of the chimney, or 60 centimetres measured from the highest part of the ridge tiles of the roof, whichever is the lower or**
- (d) in the case of article 1(5) land, it would consist of the installation of an antenna:**
  - (i) on a chimney, wall or roof slope which faces onto, and is visible from, a highway**
  - (ii) in the Broads, on a chimney, wall or roof slope which faces onto, and is visible from, a waterway or**
  - (iii) on a building which exceeds 15 metres in height**

## **Conditions**

**H.2 Development is permitted by Class H subject to the following conditions:**

- (a) an antenna installed on a building shall, so far as practicable, be sited so as to minimise its effect on the external appearance of the building and**
- (b) an antenna no longer needed for reception or transmission purposes shall be removed as soon as reasonably practicable**

## **Interpretation of Class H**

**H.3 The relevant size criteria for the purposes of paragraph H.1(a)(iii) are that:**

- (a) only one of the antennas may exceed 60 centimetres in length and**
- (b) any antenna which exceeds 60 centimetres in length must not exceed 100 centimetres in length**

**H.4 The length of the antenna is to be measured in any linear direction, and shall exclude any projecting feed element, reinforcing rim, mounting or brackets.**



# Interpretation of Part 1

For the purposes of Part 1:

*'raised' in relation to a platform means a platform with a height greater than 300 millimetres; and*

*'terrace house' means a dwellinghouse situated in a row of three or more dwellinghouses used or designed for use as single dwellings, where:*

- (a) it shares a party wall with, or has a main wall adjoining the main wall of, the dwellinghouse on either side or*
- (b) if it is at the end of a row, it shares a party wall with or has a main wall adjoining the main wall of a dwellinghouse which fulfils the requirements of sub-paragraph (a)*